

# **SYQR86N-H1**

## **SYRIS HF RFID & QR Code Reader**



**Version 01.10**  
2021/09/15

## I. Features & Specification

### Feature:

- I Support QR code and RFID for door access control
- I Compatible to read multi-ISO format HF cards
- I Scanning QR code with smart phone or paper printing.
- I Provide multi-format QR code generator software
- I Create SYRIS security QR code with valid date and share it with the visitor for temporary access.

### Specification:

HF RFID Frequency	13.56 MHz (Multi-Format)
HF Read Range	1cm ~ 5cm
HF Card Types	ISO14443A/B, ISO15693, Mifare block, SYRIS CPU card
Read Card Time	0.1 sec
Code Scan Mode	640*480 CMOS
Read 2D Code Type	QR Code, Data Matrix, PDF417,maxicode,Aztec,hanxin
Read 1D Code Type	EAN, UPC, Code 39, Code 93, Code 128, UCC/EAN 128, Codabar, Interleaved 2 of 5, Standard 25 · MSI-Plessey GS1 Databar, Industrial 25, Matrix 2 of 5
Scanning angle	Intersection angle 360°, Elevation ± 55°, Deflection angle ± 55°
Viewing Angle	Inclination 60°, Elevation 46°
Number of Cards	10,000 (8 bytes UID)
Capacity of Records	100,000
Digital Input	Up to 3 (1 DI+2 no-voltage DI share the same port with Wiegand)
Digital Output	2 Relay output
Interface	RS485 / Wiegand / Ethernet / Wi-Fi
Ethernet	10M/100M Ethernet Port
Wi-Fi	802.11 b/g/n
Status Indicator	Tricolor LED(RGB) & Beeper
Operating Temperature	-10°C ~ 60°C
Environmental Light	0~100000 LUX
Power	8V~28V DC / 2W~6W
Size(mm)	86.0 (W) x 86.0 (H)x 41.6 (D)mm (No Wire Included)

## II. Wiring Diagram

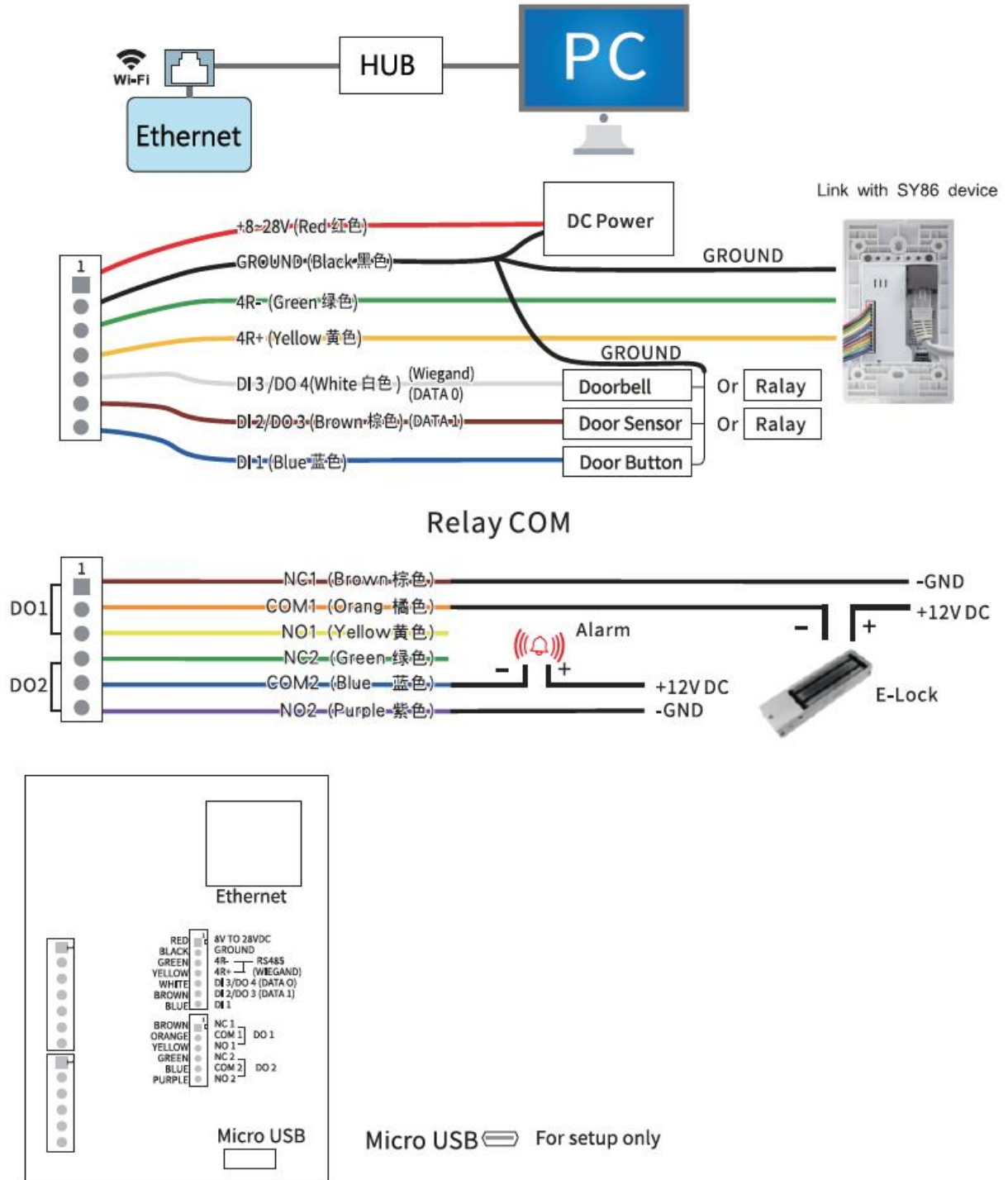

### III. Network Parameter Setting

1. Execute "NET\_Discover\_V0110.exe" and press  to search SY86N series product.
2. Factory default IP is "192.168.1.101". User can check the MAC address from product sticker with IP to confirm the device.

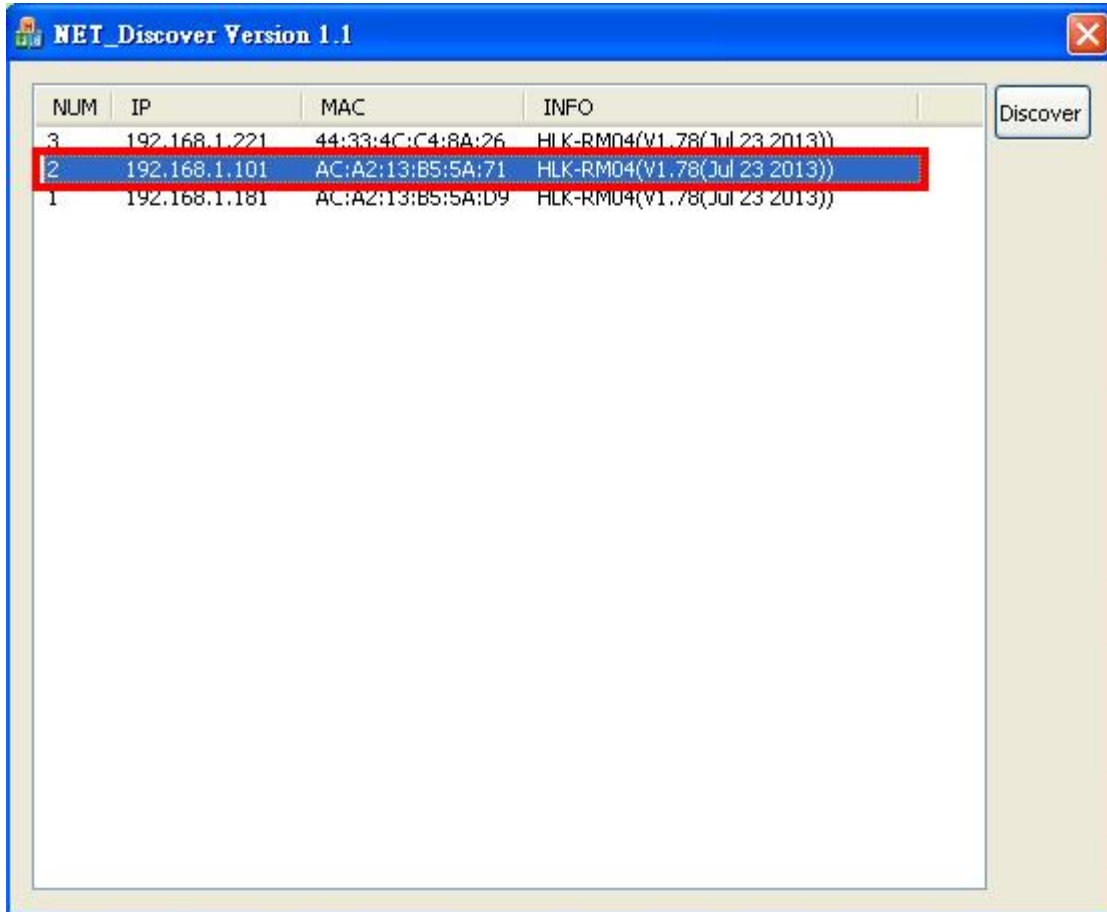

3. Double click IP (192.168.1.101) to open the web configure page(<http://192.168.1.101>)

**Default login ID / Password : admin / admin**

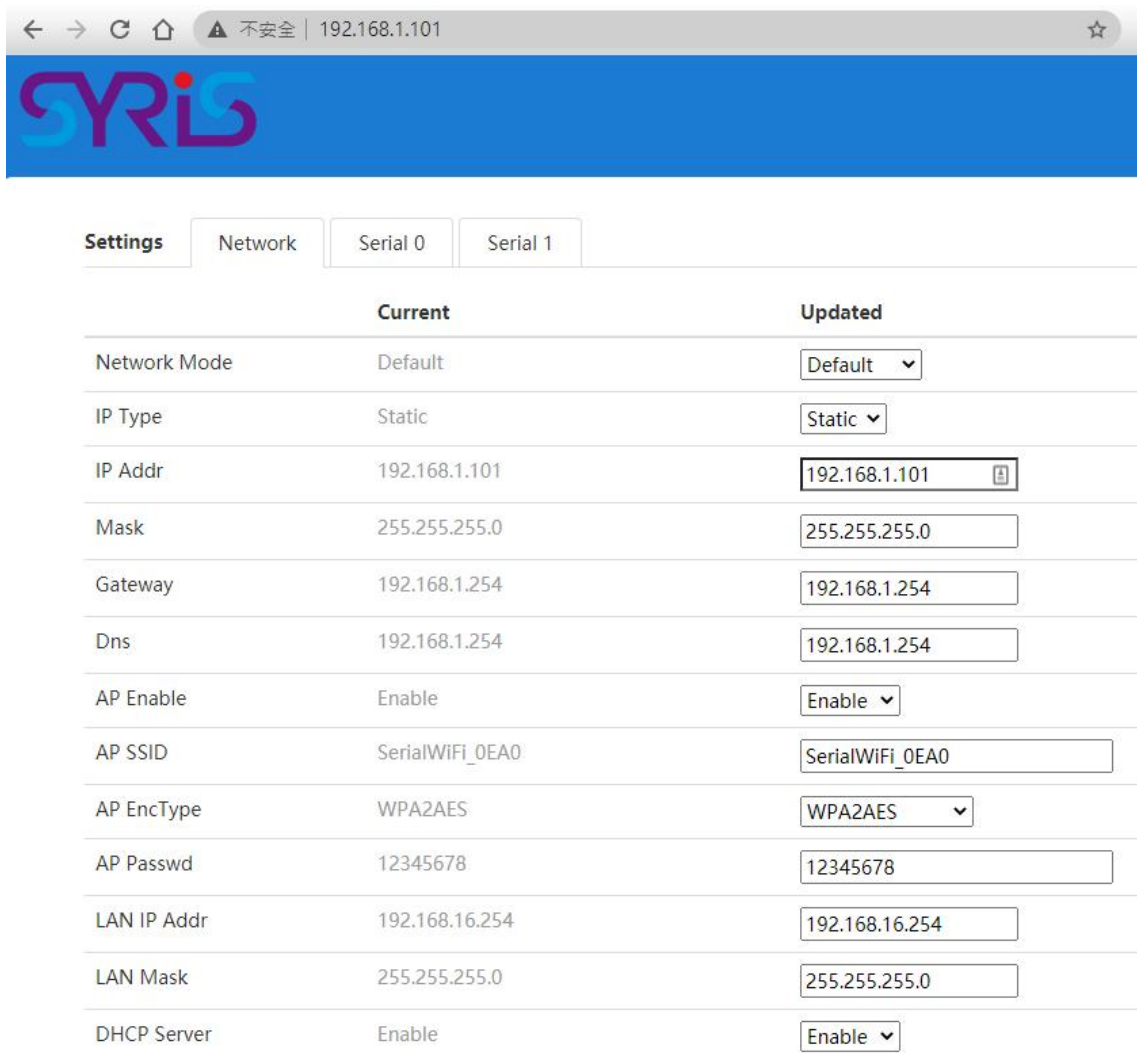

4. Default Net Mode is the same as the following. User can modify Net Mode and other parameters. If device cannot communicate properly after setting, user can reset NET module via Micro USB.

Settings			
	Network	Serial 0	Serial 1
		<b>Current</b>	<b>Updated</b>
Baudrate		230400	<input type="text" value="230400"/>
Data Width		8	<input type="text" value="8"/>
Parity		NONE	<input type="text" value="NONE"/>
Stop Bit		1	<input type="text" value="1"/>
Flow Control		Disable	<input type="text" value="Disable"/>
Socket Protocol Type		Tcp Server	<input type="text" value="Tcp Server"/>
Locale Port		5001	<input type="text" value="5001"/>
Packet Framing Lenth		1050	<input type="text" value="1050"/>
Packet Framing Timeout		3	<input type="text" value="3"/>
Packet Framing Interval		3	<input type="text" value="3"/>
TCP Timeout		0	<input type="text" value="0"/>
Reconnect Interval		200	<input type="text" value="200"/>
TCP Keep Alive		1	<input type="text" value="1"/>
TCP Max Connect		100	<input type="text" value="100"/>
Without data Timeout		60	<input type="text" value="60"/>

Communication Parameter	Factory Default
Serial Configure	230400,8,n,1
Serial Framing Length	1050
Locale/Remote Port Number	5001

## IV. Network Mode Switch

86N series device support 4 network modes: Default · ETH(Ethernet) · Wi-Fi(STA)

Default	Ethernet (DHCP) + Wi-Fi AP mode
ETH	<b>Ethernet only</b>
WIFI(STA)	Wi-Fi client mode

1. ETH : Factory default is ETH-SERIAL. ( Standard TCP/IP Reader )

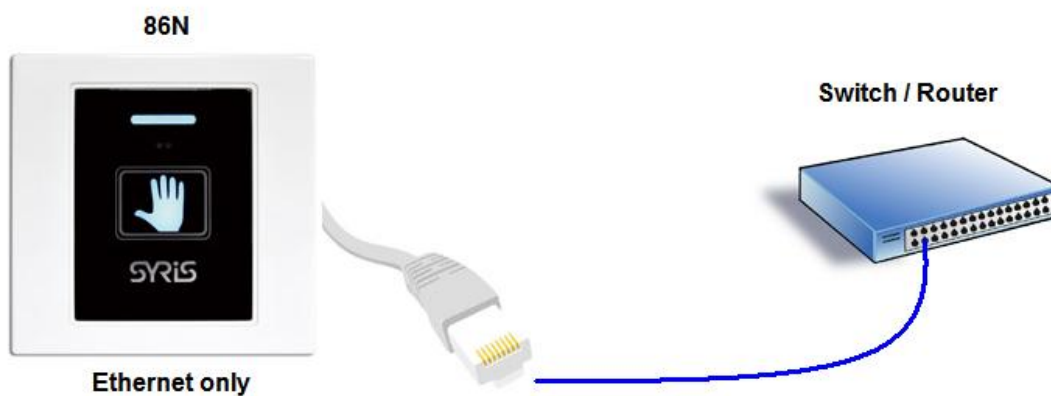

When user modify the IP and click on Apply button, device will reboot and apply the setting after 30 seconds.

	Current	Updated
Network Mode	Default	ETH ▾
IP Type	Static	Static ▾
IP Addr	192.168.1.101	192.168.1.101 
Mask	255.255.255.0	255.255.255.0
Gateway	192.168.1.254	192.168.1.254
Dns	192.168.1.254	192.168.1.254

- WIFI(STA) : 86N can be set to communicate via Wireless AP without Ethernet.



Settings		Network	Serial 0	Serial 1
	<b>Current</b>	<b>Updated</b>		
Network Mode	Default	WIFI(STA) ▾		
STA SSID	Delta-IoT	Delta-IoT	<input type="button" value="Scan"/>	
STA EncType	Open	Open ▾		
STA Passwd		<input type="text"/>		
IP Type	Static	Static ▾		
IP Addr	192.168.1.101	192.168.1.101 <input type="button" value="🔒"/>		
Mask	255.255.255.0	<input type="text" value="255.255.255.0"/>		
Gateway	192.168.1.254	<input type="text" value="192.168.1.254"/>		
Dns	192.168.1.254	<input type="text" value="192.168.1.254"/>		

S

**STA SSID:** Enter the SSID from AP you will connect to network.

**Scan:** User can scan AP in range of 86N and select one to connect. But user cannot scan the AP after changing default network mode (Ethernet only) to Wi-Fi (Client). 86N need to power off / on to enable the scan function.

**STA EncType :** Select Encrypt type for AP connection.

**Password:** Enter password for AP.

**IP Type:** DHCP is default mode. If user have to setup a static IP, please select Static.

**PS: Wi-Fi MAC address is Ethernet MAC subtract 1.**

**Ex. Ethernet MAC : AC:A2:13:B5:5A:B5 · Wi-Fi MAC : AC:A2:13:B5:5A:B4**



- 3. Default mode : Ethernet (DHCP) +Wi-Fi AP mode.  
It's Dual-Mode ( Ethernet and Wi-Fi AP · but Ethernet only support DHCP.)

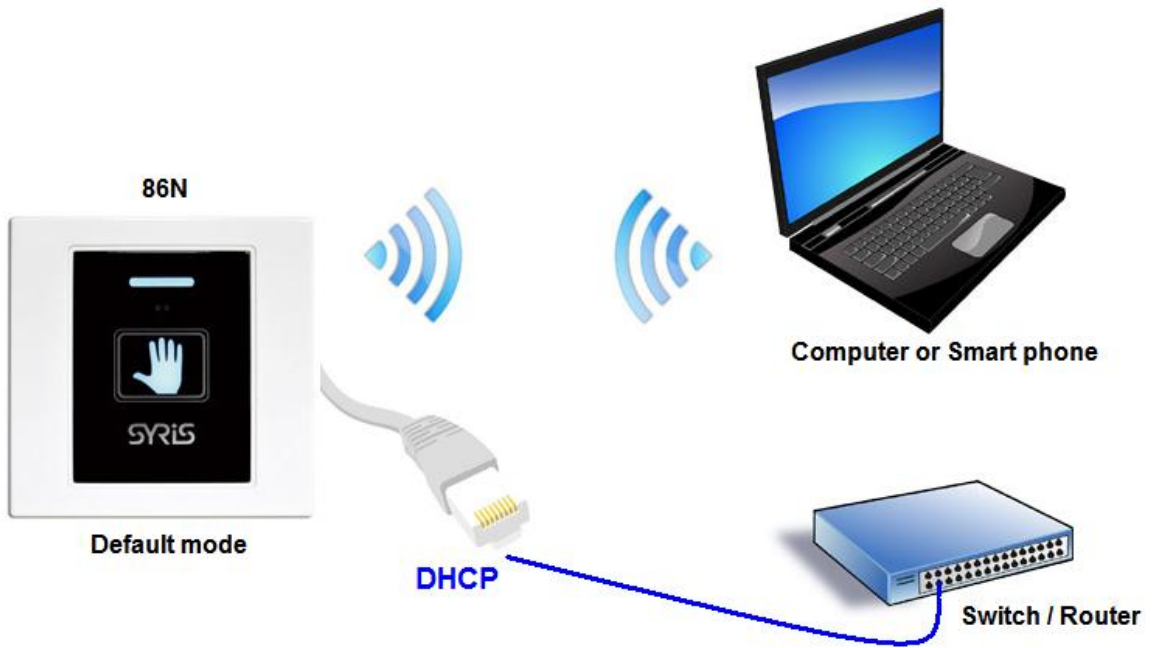

## Settings

Network

Serial 0

Serial 1

	Current	Updated
Network Mode	Default	Default ▾
IP Type	Static	Static ▾
IP Addr	192.168.1.101	192.168.1.101 
Mask	255.255.255.0	255.255.255.0
Gateway	192.168.1.254	192.168.1.254
Dns	192.168.1.254	192.168.1.254
AP Enable	Enable	Enable ▾
AP SSID	SerialWiFi_0EAO	SerialWiFi_0EAO
AP EncType	WPA2AES	WPA2AES ▾
AP Passwd	12345678	12345678
LAN IP Addr	192.168.16.254	192.168.16.254
LAN Mask	255.255.255.0	255.255.255.0
DHCP Server	Enable	Enable ▾

**AP SSID:** Setup 86N device's SSID.

**AP Passwd:** 86N device's Wi-Fi password. (Default is 12345678)

## V. USB Connection

Configure parameters via Micro USB.

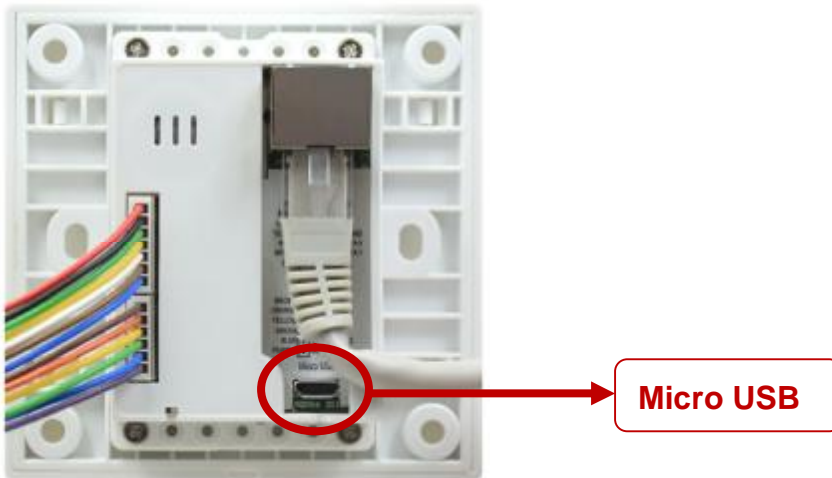

1. Install USB driver "[CDC\\_USB\\_Driver\\_VCP\\_V1.4.0\\_Setup.exe](#)"
2. System will generate a virtual COM port.

For example. Check port in device manager.(below picture is COM 3)

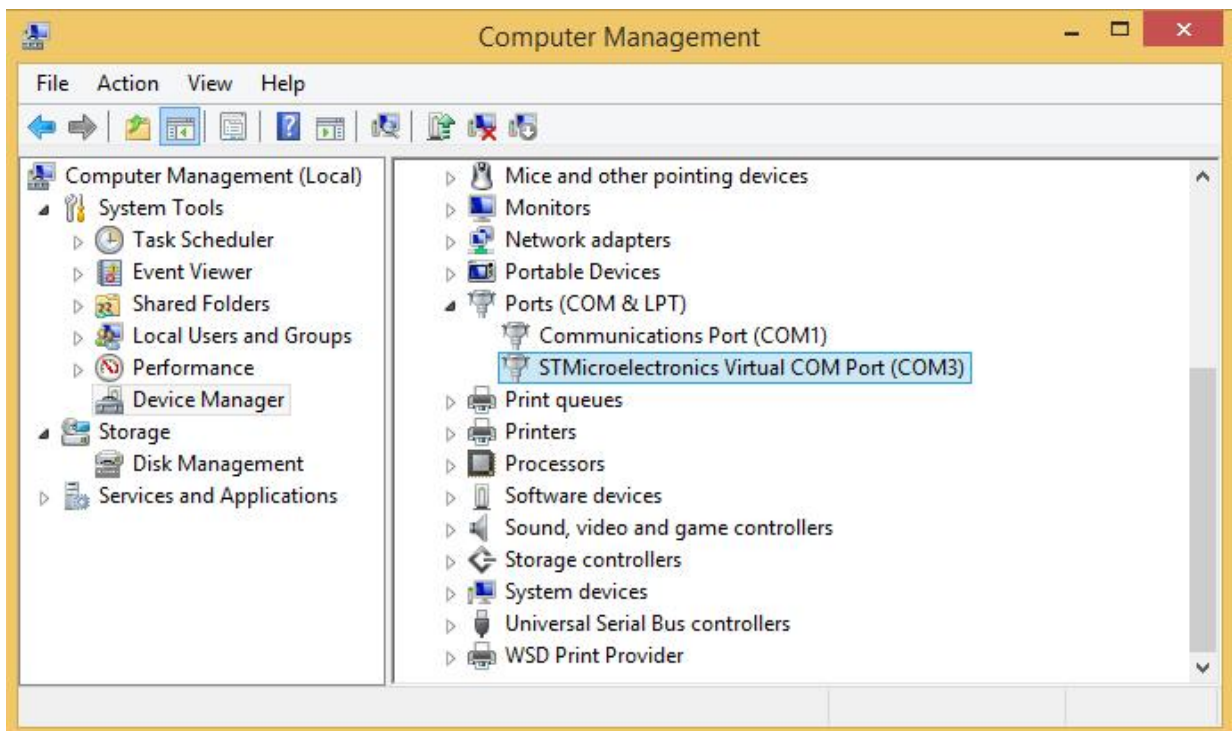

User also can update driver manually. The driver is saved in the folder that is same as following.

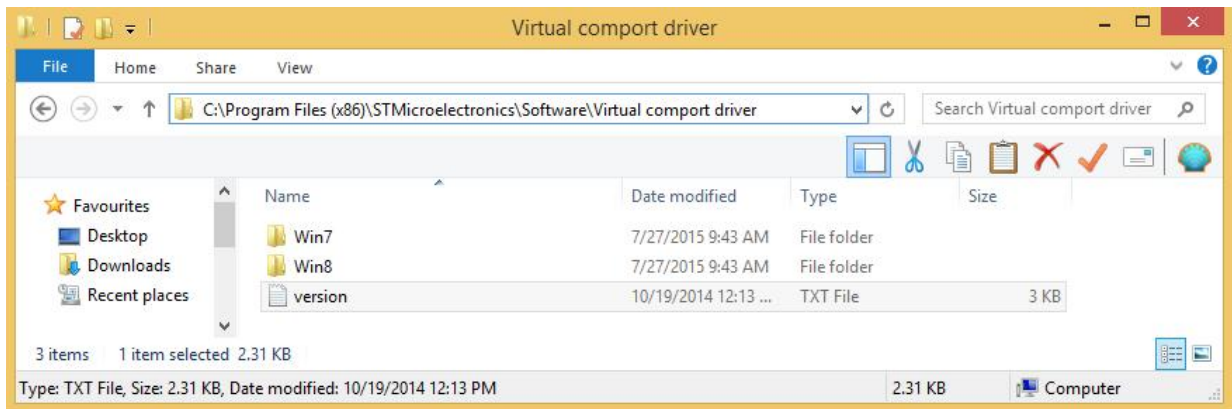

3. Get device Model information and serial number by using V8 Tools with correct COM port or Ethernet connection.

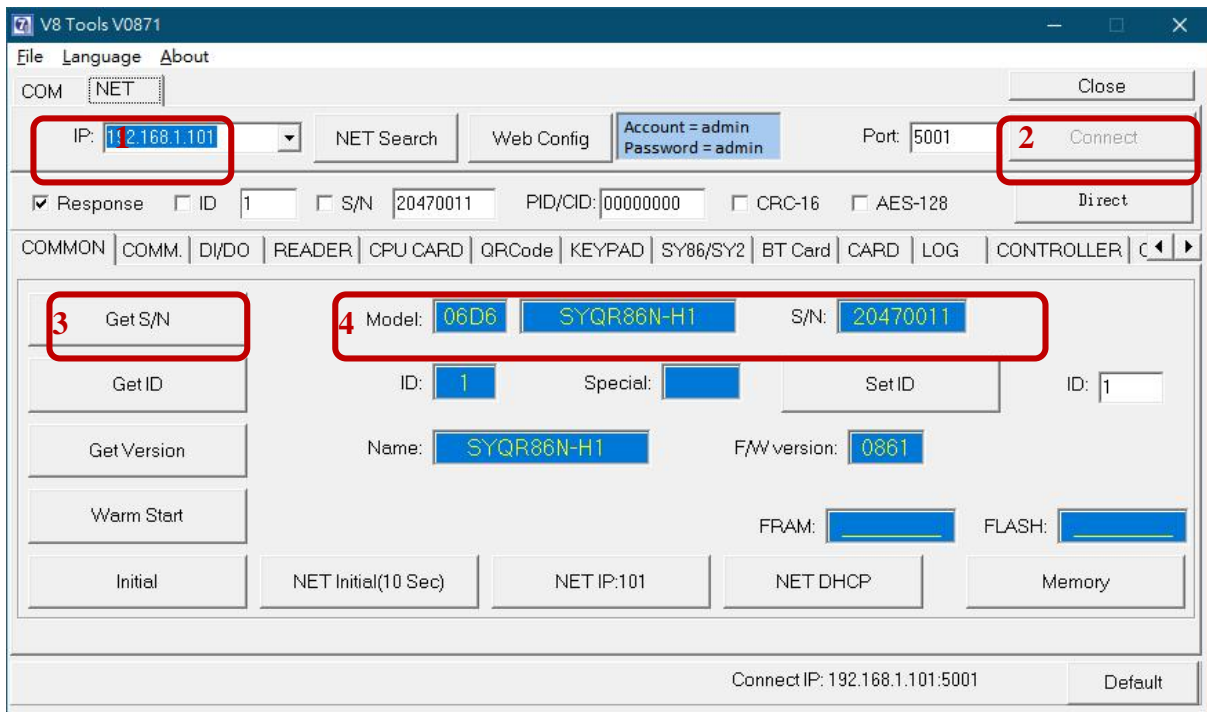

## VI.V8 Tools Tool Parameter Setting

### 1. Basic:

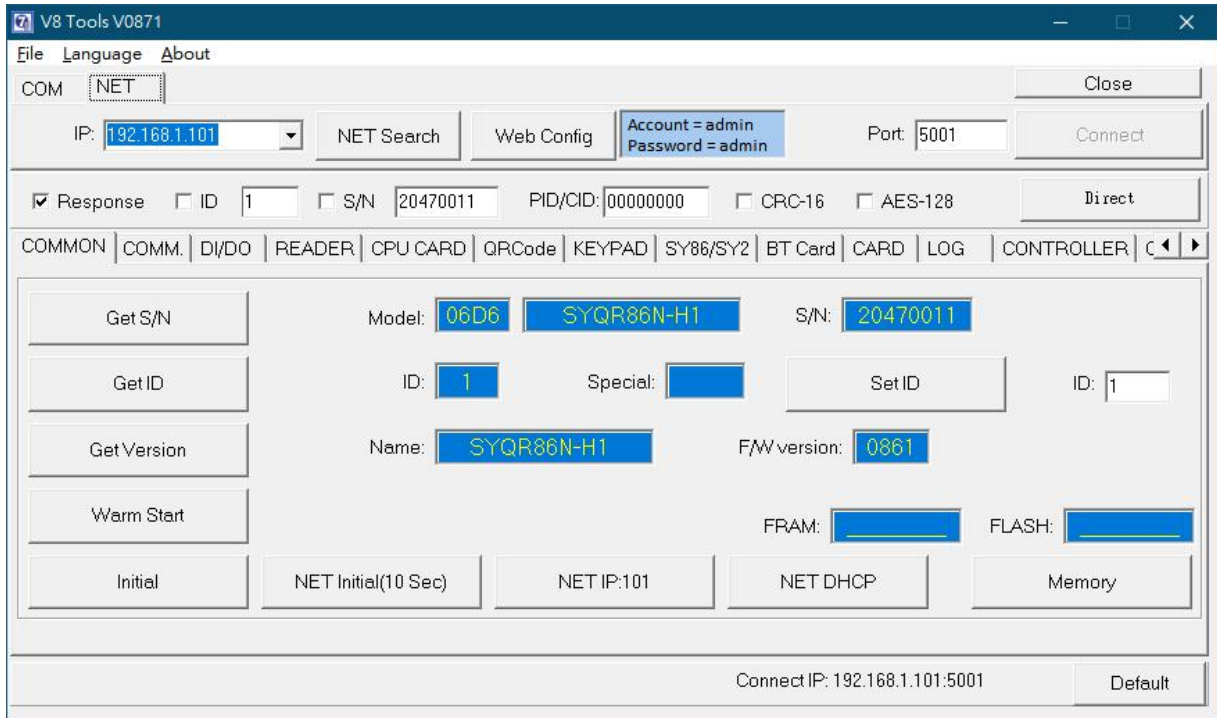

The screenshot shows the V8 Tools V0871 software interface. The window title is "V8 Tools V0871". The interface includes a menu bar with "File", "Language", and "About". Below the menu bar, there are several sections:

- COM Section:** A dropdown menu set to "NET", a "Close" button, and a "Connect" button.
- IP Section:** An IP address field set to "192.168.1.101", a "NET Search" button, a "Web Config" button, a "Account = admin" field, a "Password = admin" field, and a "Port: 5001" field.
- Response Section:** A "Direct" button and several checkboxes: "Response" (checked), "ID" (unchecked), "S/N" (unchecked), "CRC-16" (unchecked), and "AES-128" (unchecked).
- Navigation Section:** A series of tabs: "COMMON", "COMM.", "DI/DO", "READER", "CPU CARD", "QRCode", "KEYPAD", "SY86/SY2", "BT Card", "CARD", "LOG", and "CONTROLLER".
- Device Information Section:** A central area with several fields and buttons:
  - Buttons: "Get S/N", "Get ID", "Get Version", "Warm Start", "Initial", "NET Initial(10 Sec)", "NET IP:101", "NET DHCP", "Memory".
  - Fields: "Model: 06D6 SYQR86N-H1", "S/N: 20470011", "ID: 1", "Special:", "Set ID", "Name: SYQR86N-H1", "F/W version: 0861", "FRAM:", "FLASH:".
- Footer Section:** A "Connect IP: 192.168.1.101:5001" field and a "Default" button.

Basic: Get device serial number \ device ID and firmware version

Warm Start: Reboot 86N

Initial: Restore 86N to factory default (It is NOT including network setting).

NET Initial (6 sec): Restore network parameter of 86N to Default mode.

## 2. Reader

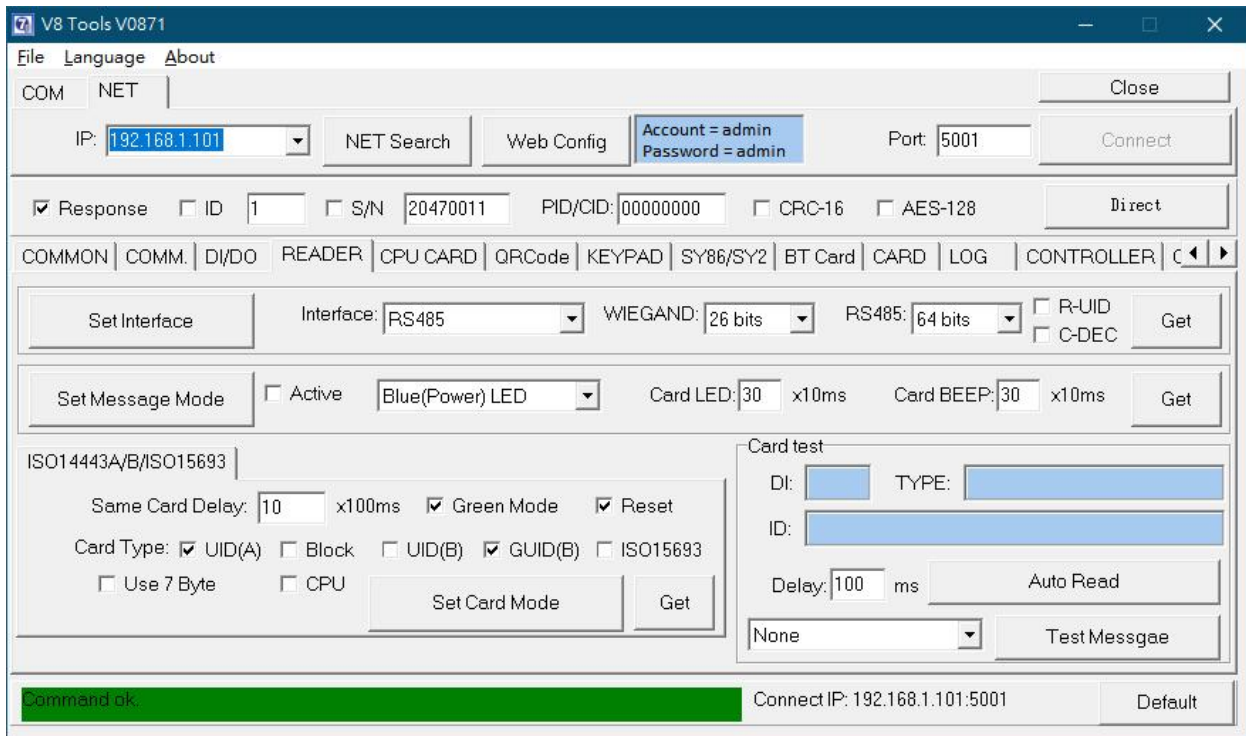

**Set Interface:** Setup reader's communication interface. Default is "RS485".

**Set Message Mode:** Click on the option active to enable message mode setting. User can setup 86N message display on panel.

Card LED: Time for read card LED ON, default is 30 x 10ms

Card Beep: Time for read card beep on, default is 30 x 10ms

### ISO14443A/B/ISO15693 :

Same Card Delay: Setup time gap for reading the same card, default is 10 x100ms (1 second)

Green Mode: Slow down the card read speed to power saving.

Reset: Reset RF IC after read card.

Card Type: Choose card type to enable 86N read specific card.

UID(A): Read ISO14443A Card UID.

Block: Read Block data (Must disable other card type).

UID(B): Read ISO14443B Card UID.

GUID(B): Read the China second generation of resident identification card.

ISO15693: Read ISO15693 Card UID

7 byte: Read 7byte format Card UID

Card Test: Test the reader function.

### 3. QR code

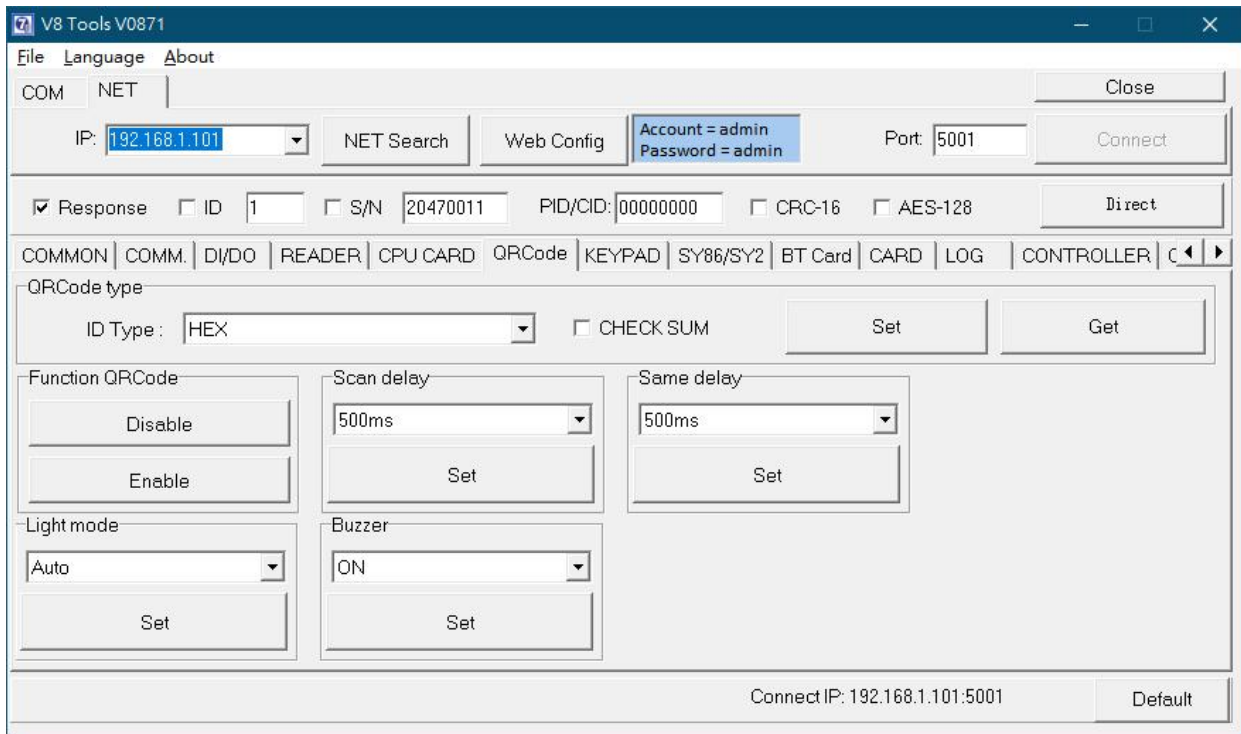

The screenshot shows the V8 Tools V0871 software interface. The 'QRCode' tab is selected in the top navigation bar. The 'QRCode type' section is expanded, showing the 'ID Type' set to 'HEX' and the 'CHECK SUM' checkbox unchecked. Below this, there are sections for 'Function QRCode' (with 'Disable' and 'Enable' buttons), 'Scan delay' (set to 500ms), 'Same delay' (set to 500ms), 'Light mode' (set to 'Auto'), and 'Buzzer' (set to 'ON'). Each of these sections has a 'Set' button. At the bottom right, there is a 'Connect IP: 192.168.1.101:5001' field and a 'Default' button.

Setup reader's QR code scan format and parameters

ID Type is setup QR code output format.

This option is depends on QR code generator. (Default is DEC without CHECK SUM.)

#### **DEC** (0~9)

UID = 0000000012345678

QRcode = 0000000012345678

Reader access UID = 000000000BC614E (DEC to HEX)

#### **DEC+Checksum** (0~9)

UID = 0000000012345678

QRcode = 00000000123456786, CheckSum (6) = 1+2+3+4+5+6+7+8 = 36(Single digit)

Reader access UID = 000000000BC614E

#### **HEX** (0~F)

UID = AB00000012345678

QRcode = AB00000012345678

Reader access UID = AB00000012345678

**HEX+Checksum** (0~F)

UID = AB00000012345678

QRcode = AB000000123456789, CheckSum (9) =A+B+1+2+3+4+5+6+7+8 =39(Single digit)

Reader access UID = AB00000012345678

Function QRcode: Default is disable. Enable this function will allow configure some function from QR code.

Scan delay: QR code scan time.

Same delay: QR code's same card time.

Light mode: QR code module's light when detected moving.

Buzzer: QR code module's buzzer.

ID Type "SID"/ "SID date" are use for "SYRIS security QR code".

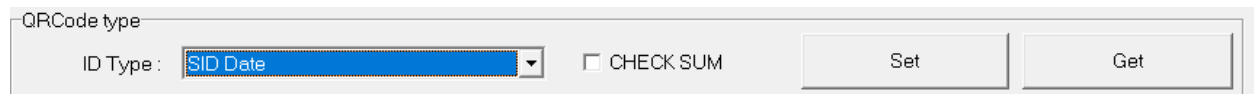

The QR code type of the QR code generator software should be set to be the same as the ID type of QR86.

QR86 ID type	SYRIS QR Code software
HEX	HEX
HEX + CHECK SUM	HEX + check
DEC	DEC
DEC + CHECK SUM	DEC + check
SID	SYRIS Security QR code
SID date	SYRIS Valid Security QR code
SID Access	SYRIS Valid Security QR code with 128 door groups

Note. SID Access was support since V.08.63



## VII. SYRIS security QR code

### QR code generator software

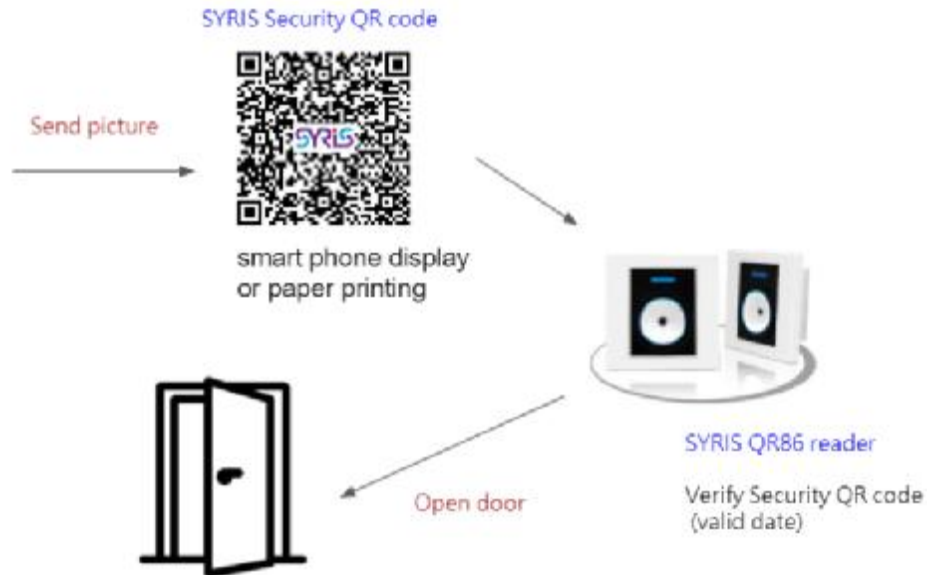

### I SYRIS security QR code:

SYQR86 reader will verify the SID key and PID/CID of security QR code.

Verify OK → Transmit correct UID to controller/network.

Verify Error → Reject message (Red LED and warning beep)

1. Setup SYQR86's ID type to SID

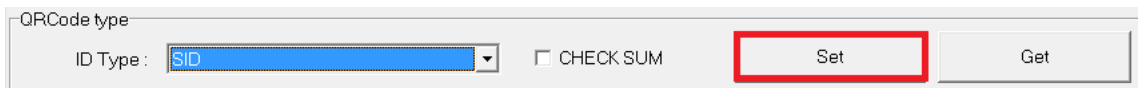

2. Setup Correct SID key, APP ID and key No. in "CPU CARD" tab

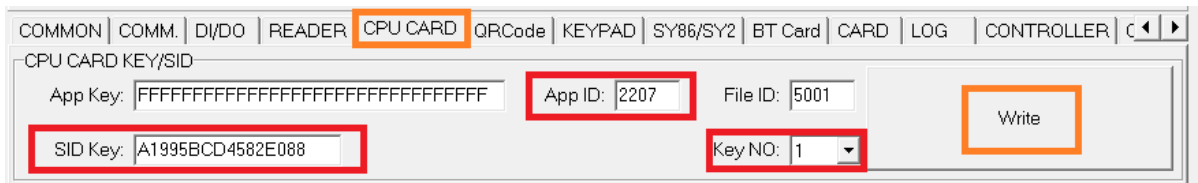

- Execute "SYRIS QrCode.exe" generator software and input security data.  
(SYRIS QRCode V0107\_Example\SYRIS QRCode\bin\Debug\SYRIS QRCode.exe)



Card number: Customize UID for QR code.

Display name: Customize name (option)

APP ID: Security parameter, need setup the same with SYQR86.

Key No.: Security parameter, need setup the same with SYQR86.

SID key: Security parameter, need setup the same with SYQR86.

PID/CID: Product' ID, please get this ID on the SYQR86 sticker. (ex. **4400 5001**)

- Click "Generate" to generate security QR code and send to mobile or paper print to read.

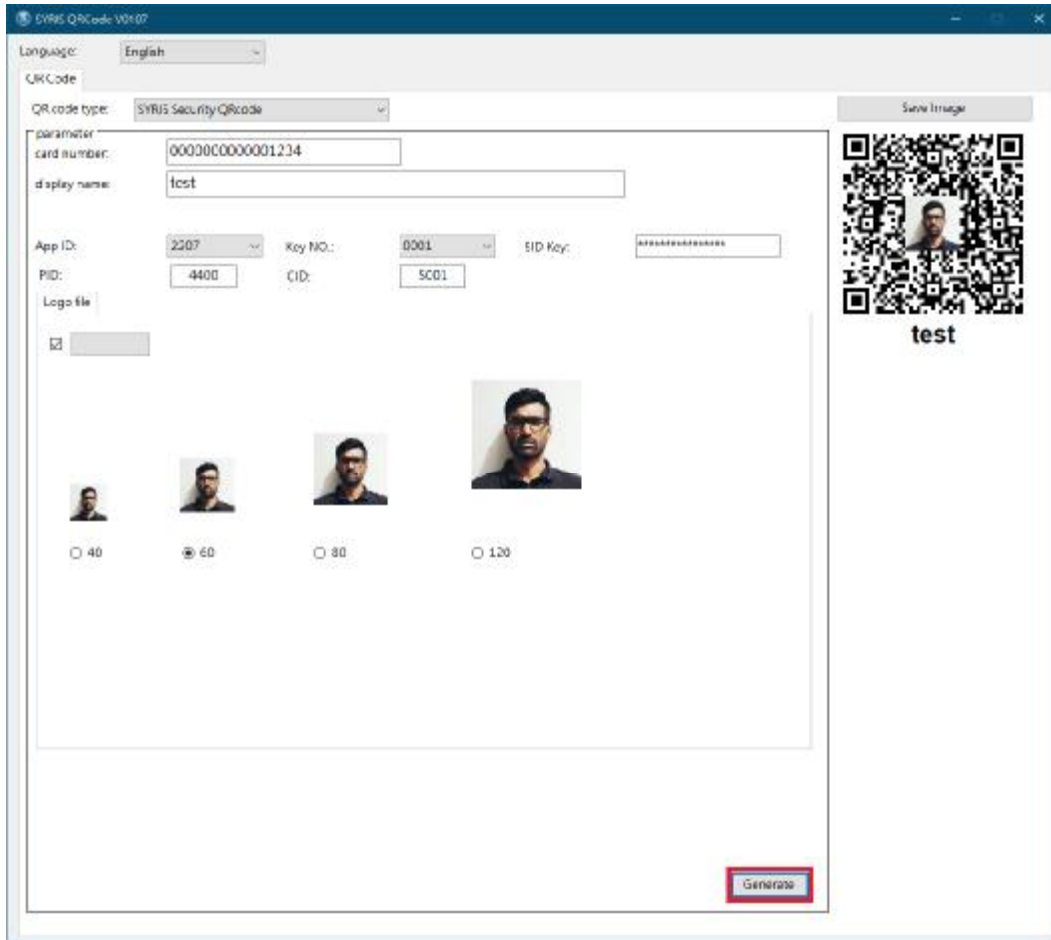

5. Execute "SYRIS TCP reader utility" to connect reader and start to read.

(This software only work with "auto send reader mode".)

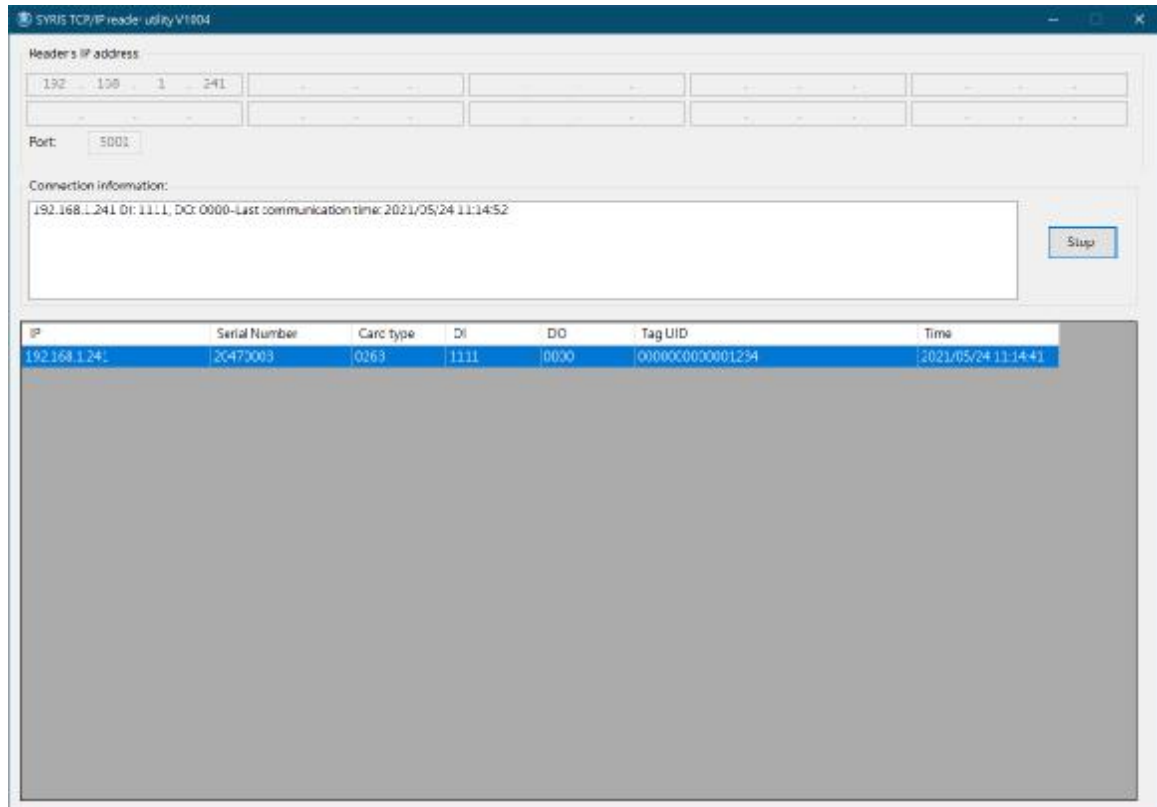

Read log will auto save in software's folder.

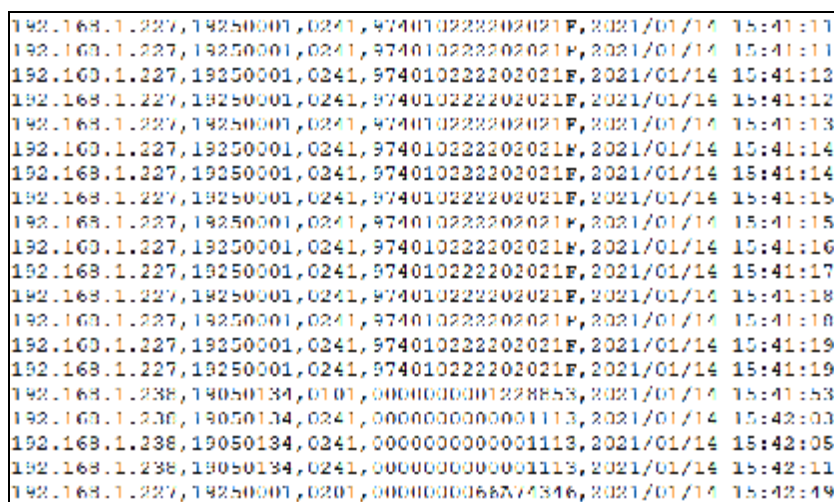
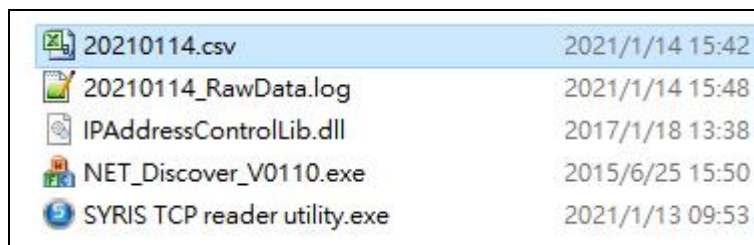

6. SYQR86 only read security QR code format.

If you need trigger relay to access when read security QR code, please setup DO in "SY86/SY2" tab as below picture.

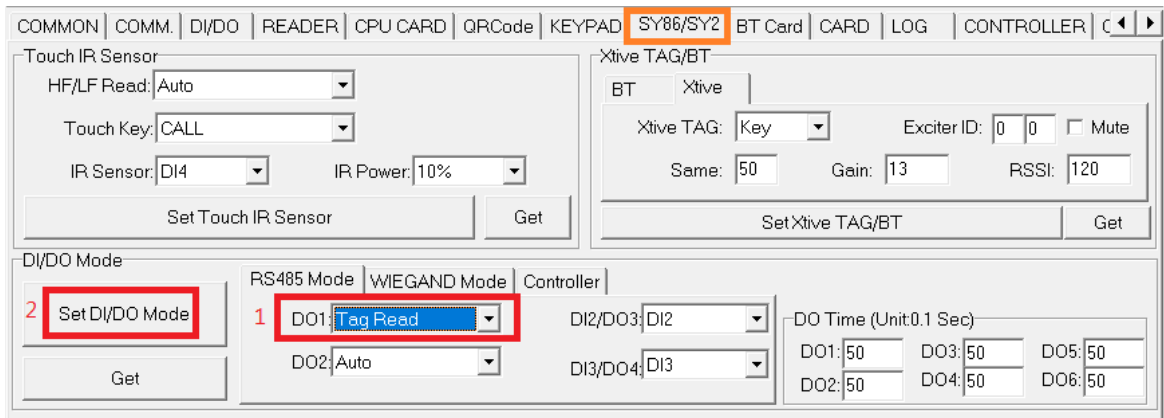

The screenshot shows the configuration interface for the SYQR86N SYRIS HF RFID & QR Code Reader. The 'SY86/SY2' tab is selected. The interface is divided into several sections:

- Touch IR Sensor:** HF/LF Read: Auto, Touch Key: CALL, IR Sensor: DI4, IR Power: 10%. Buttons: Set Touch IR Sensor, Get.
- Xtivity TAG/BT:** BT, Xtivity. Xtivity TAG: Key, Exciter ID: 0 0, Mute. Same: 50, Gain: 13, RSSI: 120. Buttons: Set Xtivity TAG/BT, Get.
- DI/DO Mode:** 2 Set DI/DO Mode. Buttons: Get.
- RS485 Mode | WIEGAND Mode | Controller:** 1 D01: Tag Read, D02: Auto, DI2/D03: DI2, DI3/D04: DI3. DO Time (Unit: 0.1 Sec): D01: 50, D02: 50, D03: 50, D04: 50, D05: 50, D06: 50.

**I SYRIS valid security QR code:**

SYQR86 reader will verify the SID key, PID/CID and valid time of security QR code.

Verify OK → Transmit correct UID to controller/network.

Verify Error → Reject message (Red LED and waring beep)

1. Setup SYQR86's ID type to SID Date.

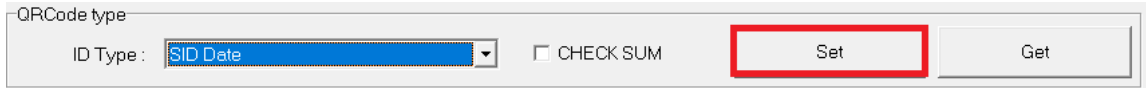

QRCode type  
 ID Type: SID Date  CHECK SUM Set Get

2. Set correct time to SYQR86 and get current time to verify in "CLOCK/MASTER" tab.

Click "Set Clock" will sync computer's time to reader.

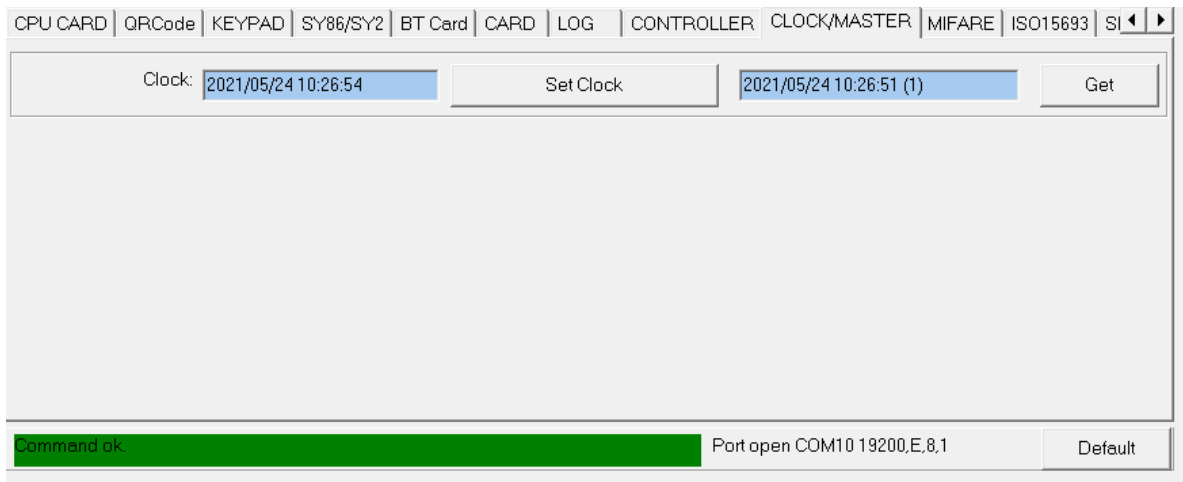

CPU CARD | QRCode | KEYPAD | SY86/SY2 | BT Card | CARD | LOG | CONTROLLER | CLOCK/MASTER | MIFARE | ISO15693 | SI ◀ ▶

Clock: 2021/05/24 10:26:54 Set Clock 2021/05/24 10:26:51 (1) Get

Command ok Port open COM10 19200,E,8,1 Default

3. Setup Correct **SID key**, **APP ID** and **key No.** in "CPU CARD" tab



COMMON | COMM. | DI/DO | READER | CPU CARD | QRCode | KEYPAD | SY86/SY2 | BT Card | CARD | LOG | CONTROLLER | c ◀ ▶

CPU CARD KEY/SID

App Key: FFFFFFFFFFFFFFFFFFFFFFFFFFFFFFFF App ID: 2207 File ID: 5001 Write

SID Key: A1995BCD4582E088 Key NO: 1

- Execute "SYRIS QrCode.exe" generator software and input security data.



QR code type: SYRIS Valid Security QRcode

parameter

card number: 000000000007865A

display name: limit test

App ID: 2201 Key NO.: 0001 SID Key: \*\*\*\*\*

PID: 4400 CID: 5001

card validity period:  1 hr  2 hr  4 hr  8 hr  1 day  custom

2021/05/24 11:49 ~ 2021/05/24 15:49

Password: \*\*\*\*\*

card type: Visitor Card card level: 01

Card number: Customize UID for QR code.

Display name: Customize name (option)

APP ID: Security parameter, need setup the same with SYQR86.

Key No.: Security parameter, need setup the same with SYQR86.

SID key: Security parameter, need setup the same with SYQR86.

PID/CID: Product' ID, please get this ID on the SYQR86 sticker. (ex. **4400 5001**)

**Card validity period: Set this QR code's valid time.**

Password, card type and card level are used for access control system. (option)

5. Click "Generate" to generate security QR code and send to mobile or paper print to read.

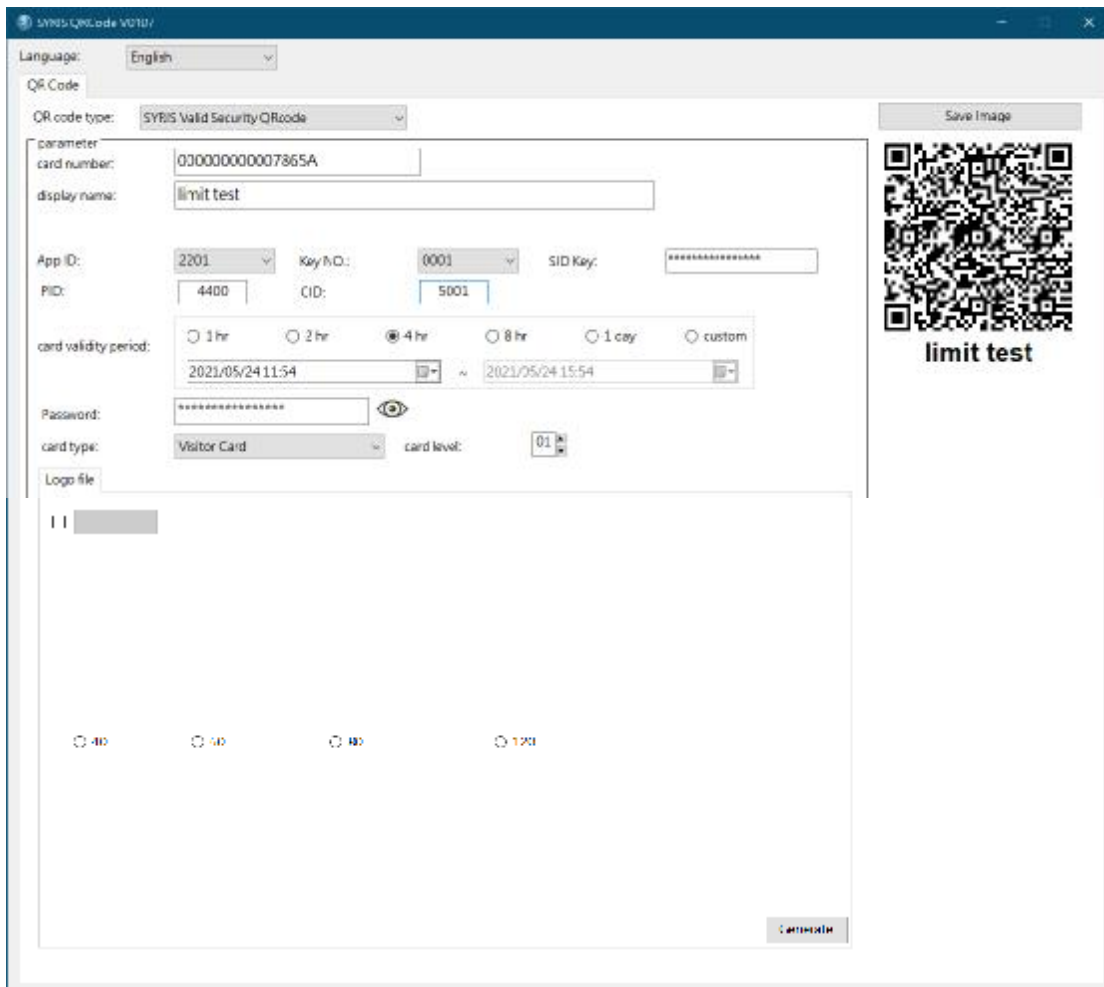



- Execute "SYRIS TCP reader utility" to connect reader and start to read.

(This software only work with [auto send reader mode.](#))

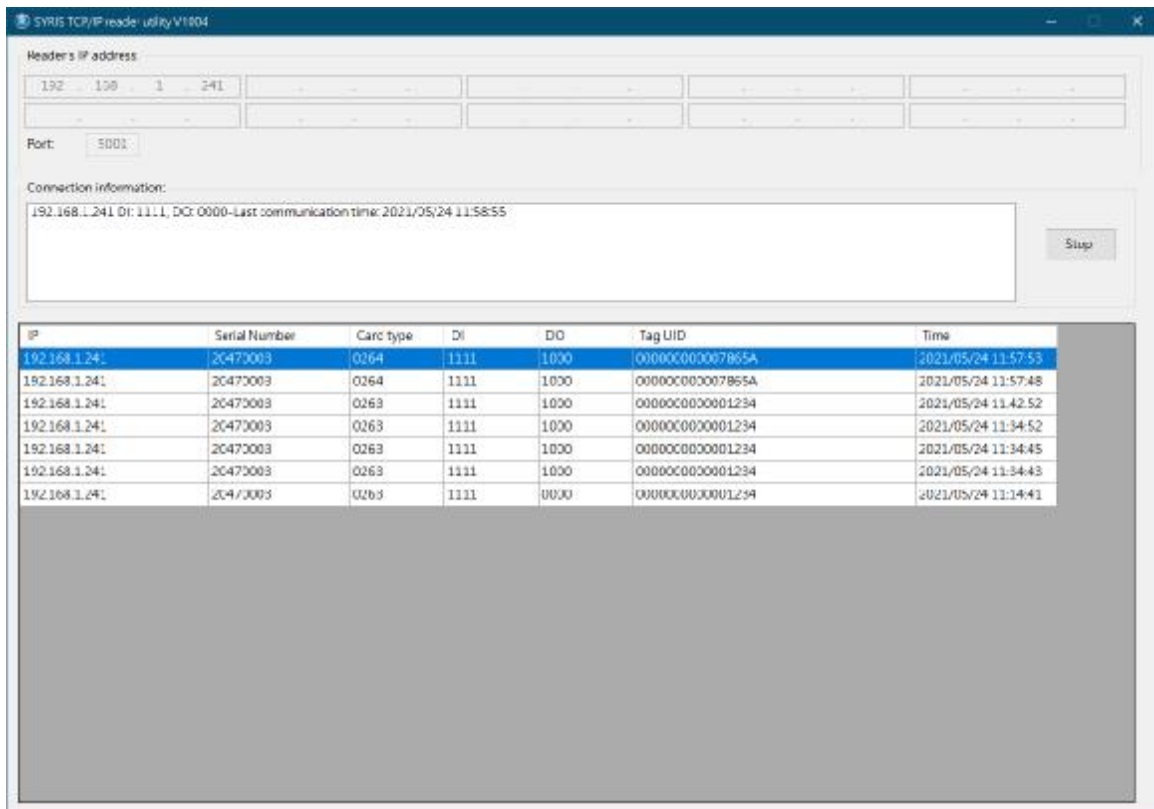

- SYQR86 only read security QR code format and verify valid time.

Card type:

0101	EM tag UID	0211	Desfire tag UID
0201	Mifare tag UID	0261	QR code (DEC)
0202	Mifare block data	0262	QR code (HEX)
0203	ISO 14443B tag UID	0263	QR code (SID)
0204	ISO15693 tag UID	0264	QR code (SID date)
0241	UHF tag UID		

**I SYRIS Valid Security QR code with 128 door groups:**

SYQR86 reader will verify door group, SID key, PID/CID and valid time of security QR code.

Verify OK → Transmit correct UID to controller/network.

Verify Error → Reject message (Red LED and waring beep)

1. Setup SYQR86's ID type to SID Access.

2. Set correct time to SYQR86 and get current time to verify in "CLOCK/MASTER" tab.

Click "Set Clock" will sync computer's time to reader.

3. Setup Correct **SID key**, **APP ID** and **key No.** in "CPU CARD" tab

4. Set reader's door group number. (No.1~No.128)

5. Execute "SYRIS QrCode.exe" generator software and input security data.

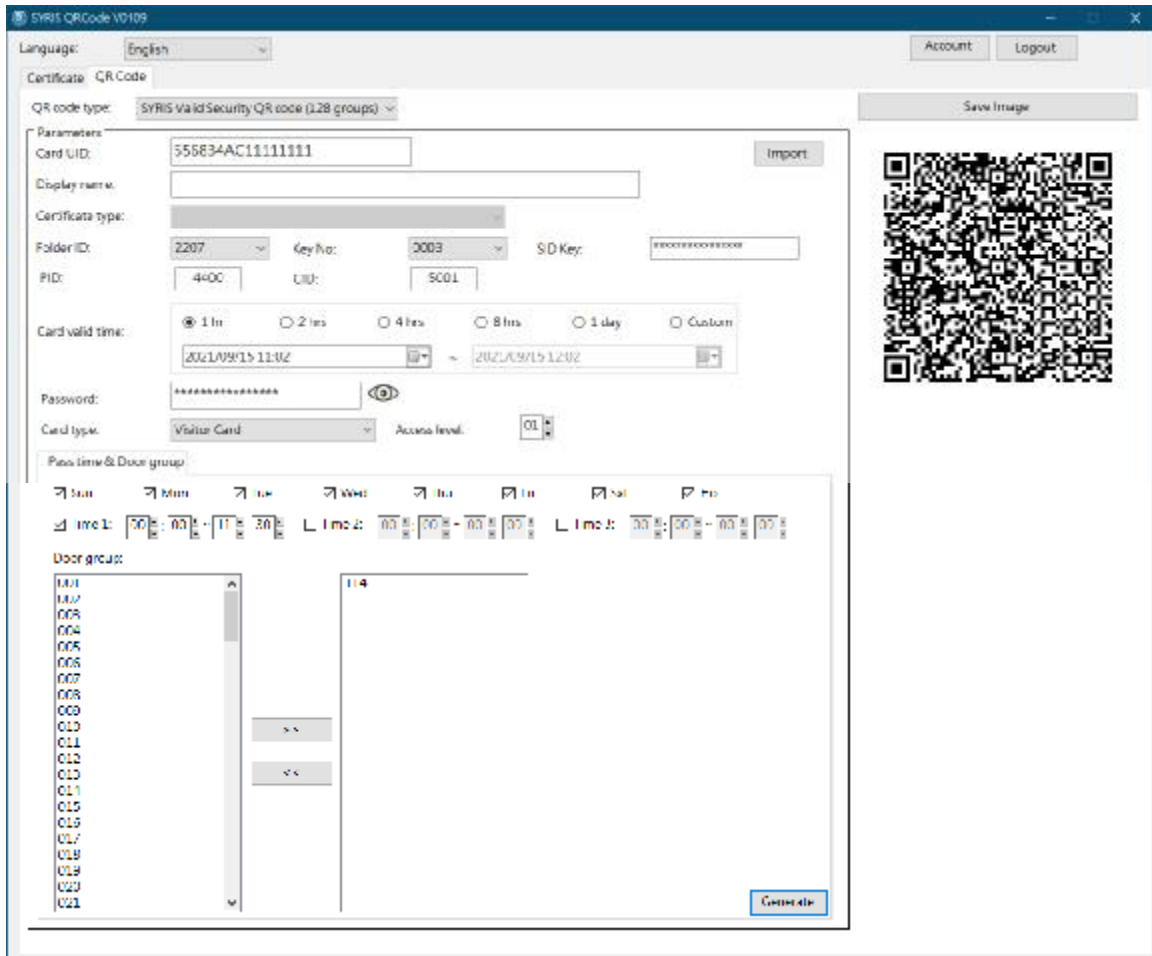

Card UID: Customize UID for QR code.

Display name: Customize name (option)

Folder ID: Security parameter, need setup the same with SYQR86.

Key No.: Security parameter, need setup the same with SYQR86.

SID key: Security parameter, need setup the same with SYQR86.

PID/CID: Product' ID, please get this ID on the SYQR86 sticker. (ex. **4400 5001**)

**Card validity period: Set this QR code's valid time.**

Password, card type and card level are used for access control system. (option)

Pass time and door group:

Pass time: Select valid pass time for QR code

Door group: Select door group to pass for QR code.

## Auto send reader mode

1. Un- Select "Controller Mode" and then click "Set DI/DO Mode" to disable controller mode.

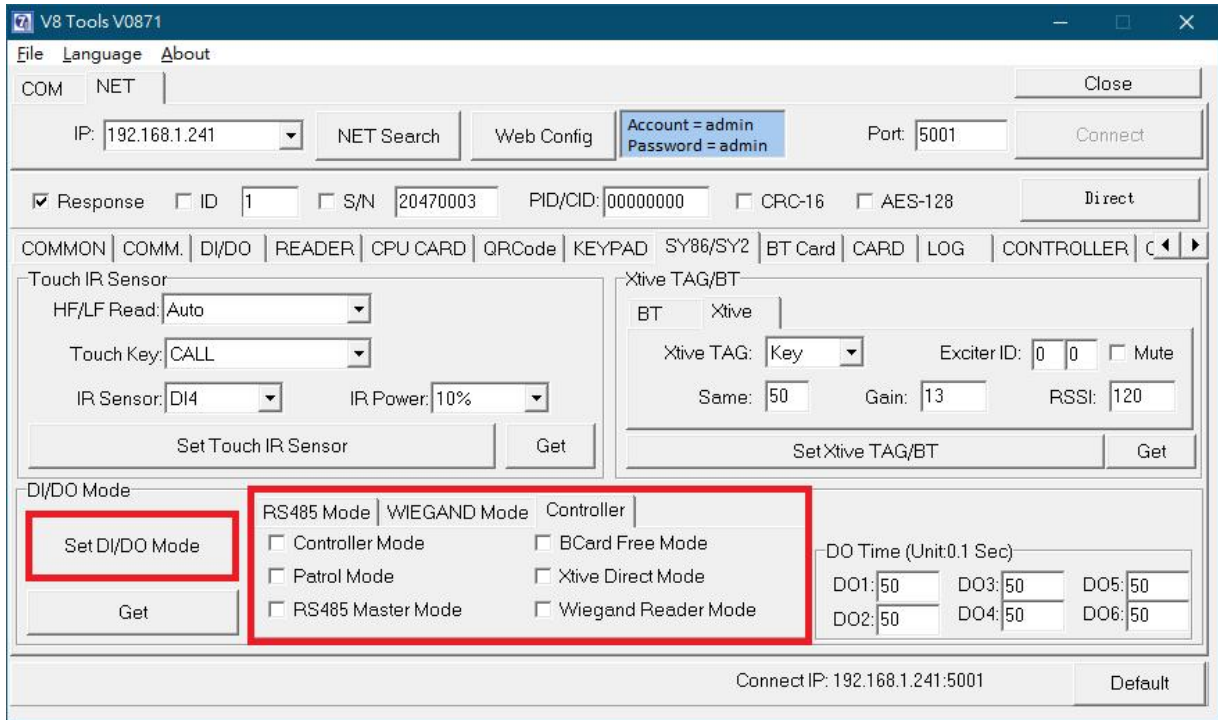

2. Select "EN" (means enable), "S/N", "CLR", "CRC" and set heartbeat to 50 (means 5 sec) and then click "Auto Mode" to finish configure.

