

# **SYSR86N-HBX1**

## **Standard TCP/IP Reader**

### **Manual**



**Version 01.12**  
2022/03/10

## I. Features & Specification

### Feature:

- I Standard 86.0(W)x86.0(H) mm
- I Waving Hand / Touch Panel to Access Door
- I Support to read standard 13.56MHz RFID card
- I Relay for door bell 、 light or EM lock
- I Quick Setup via Micro USB
- I Support Standard Wiegand interface
- I Door sensor detective ( Door Open Timeout 、 Forcible Entry Alarm )
- I Support Black card List
- I Support to access door via Bluetooth 、 Xtive RFID Tag

### Specification:

Card Frequency	13.56MHz
Card Types	ISO14443A/B, ISO15693, Mifare block, SYRIS CPU card
Card Read Range	1~5 cm
Ethernet	10/100 base-T Ethernet
Wi-Fi	802.11 b/g/n
Black/White List	10,000
Event Log	100,000
Baud Rate	19,200 bps (4,800~230,400 bps)
Read Card Time	0.1 second
Keypad	1 Key (Capacitive Touch)
IR Sensor	1 IR Sensor, adjustable range 0-10 cm
Status Indicator	Tricolor LED(RGB)
Touch Status Indicator	Tricolor LED(RGB)
Interface	Ethernet, Wi-Fi, Wiegand, RS-485, USB
Device ID	0001~9999
Digital Input	Up to 3 (1 no-voltage DI +2 no-voltage DI share the same port with Wiegand)
Digital Output	Up to 4 (2 Relay + 2 output share the same port with Wiegand)
Voice Output	On-Board Buzzer
Operation/Storage Temperature	-10℃ ~+60℃ / -20℃ ~+70℃
Power	8V ~ 28V DC / 1W ~ 6W
Size(mm)	86(W) x 86(H) x 41.6(D) mm (No Wire Included)

## II. Wiring Diagram

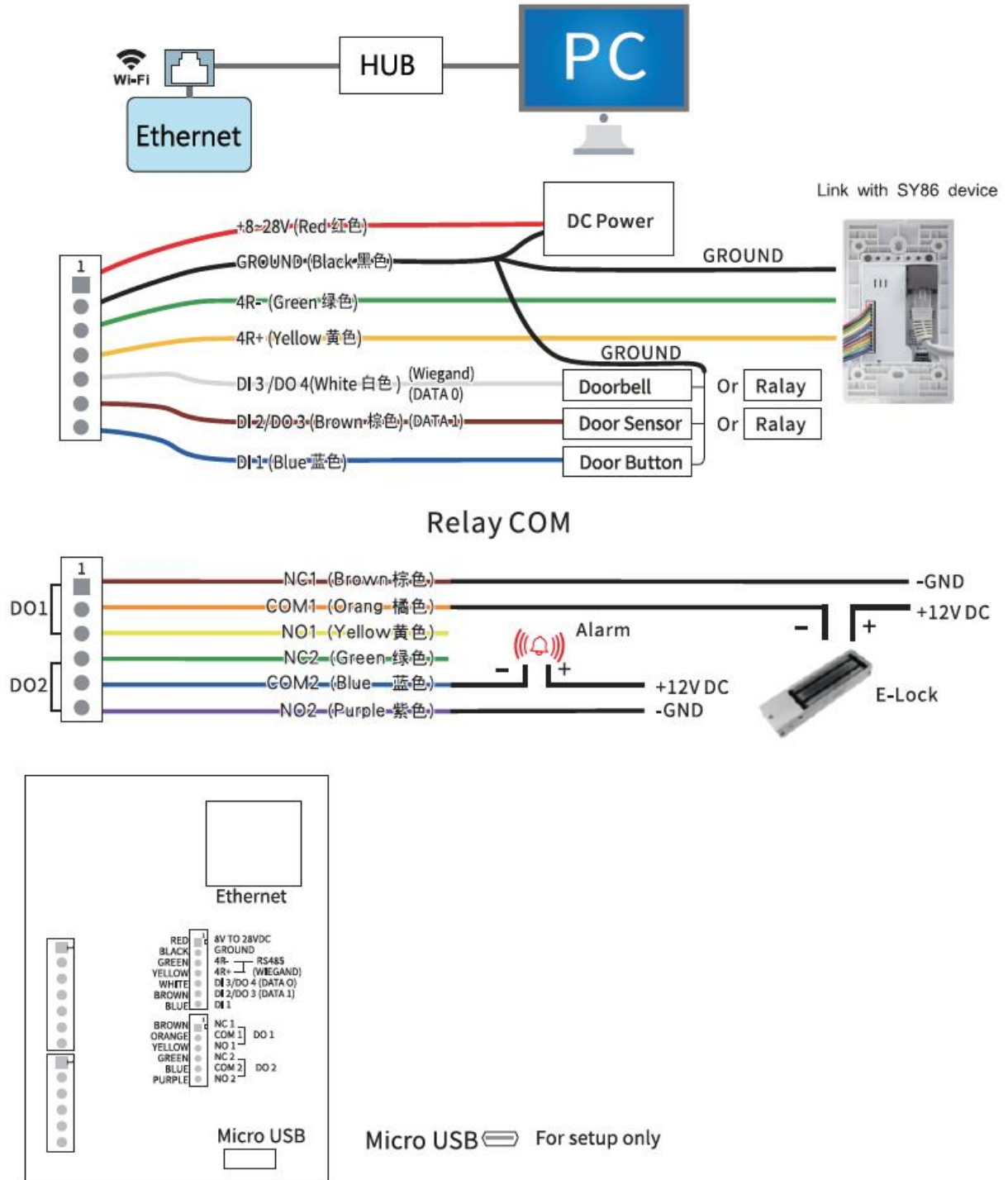

### III. Network Parameter Setting

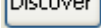
1. Execute "NET\_Discover\_V0110.exe" and press  to search SY86N series product.
2. Factory default IP is "192.168.1.101". User can check the MAC address from product sticker with IP to confirm the device.

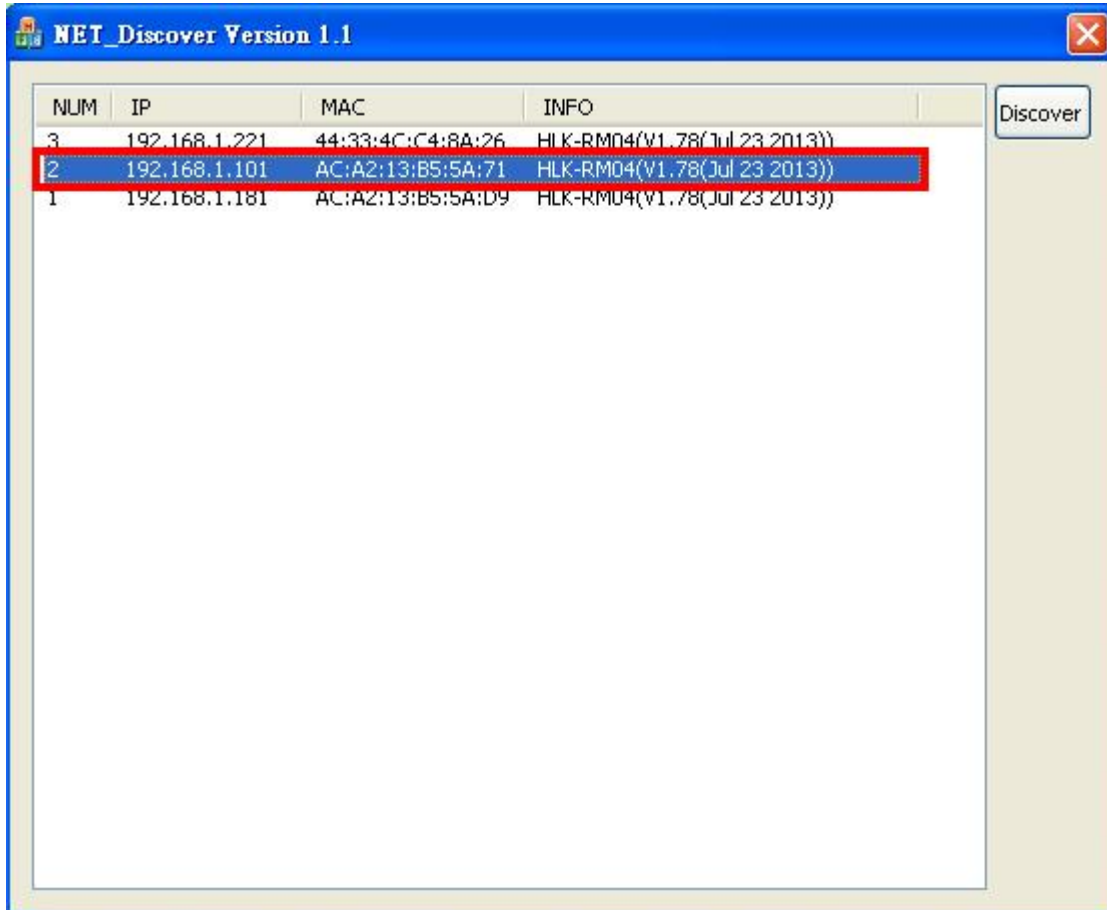

3. Double click IP (192.168.1.101) to open the web configure page(<http://192.168.1.101>)

**Default login ID / Password : admin / admin**

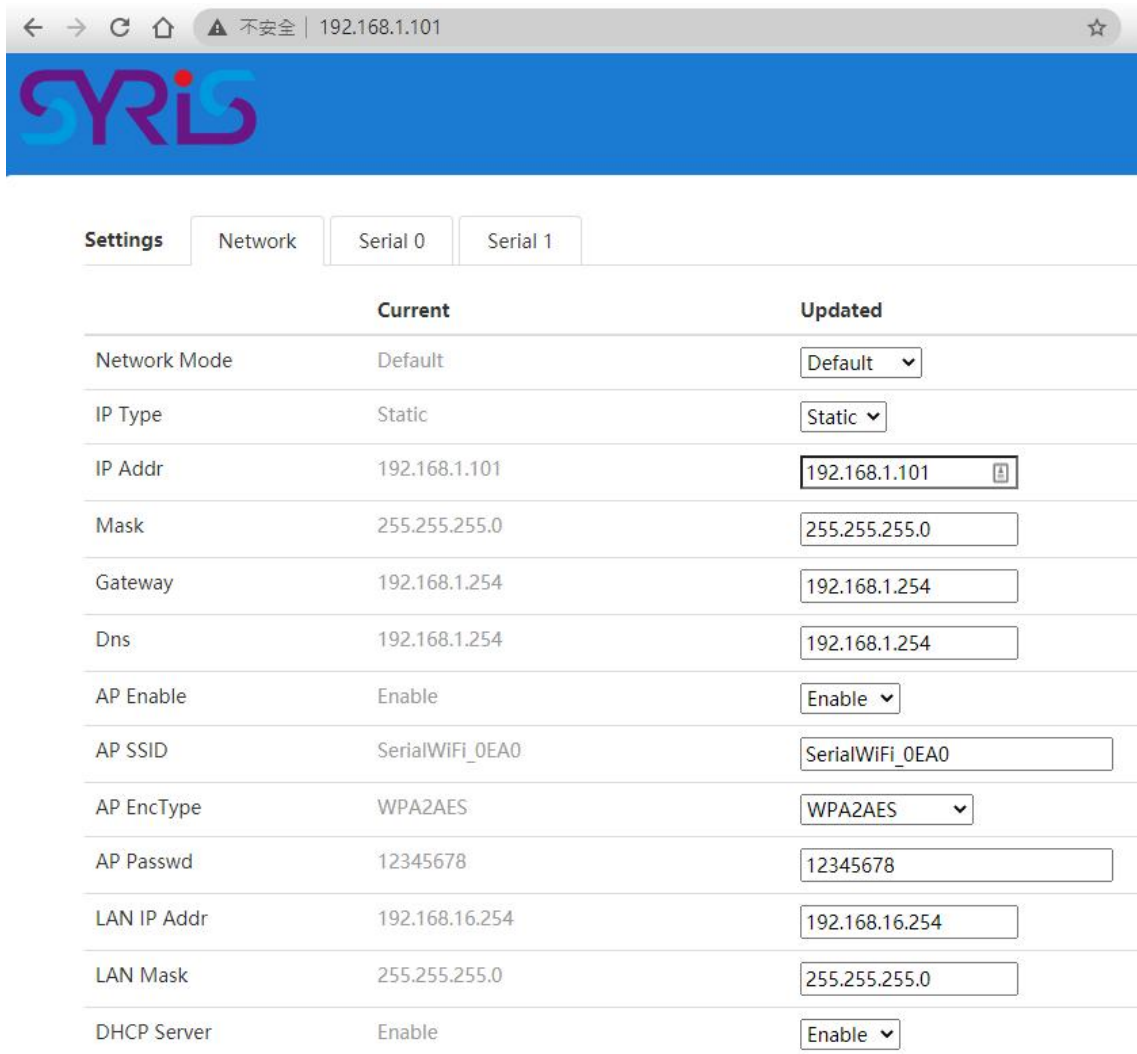

4. Default Net Mode is the same as the following. User can modify Net Mode and other parameters. If device cannot communicate properly after setting, user can reset NET module via Micro USB.

Settings			
	Network	Serial 0	Serial 1
		<b>Current</b>	<b>Updated</b>
Baudrate		230400	<input type="text" value="230400"/>
Data Width		8	<input type="text" value="8"/>
Parity		NONE	<input type="text" value="NONE"/>
Stop Bit		1	<input type="text" value="1"/>
Flow Control		Disable	<input type="text" value="Disable"/>
Socket Protocol Type		Tcp Server	<input type="text" value="Tcp Server"/>
Locale Port		5001	<input type="text" value="5001"/>
Packet Framing Lenth		1050	<input type="text" value="1050"/>
Packet Framing Timeout		3	<input type="text" value="3"/>
Packet Framing Interval		3	<input type="text" value="3"/>
TCP Timeout		0	<input type="text" value="0"/>
Reconnect Interval		200	<input type="text" value="200"/>
TCP Keep Alive		1	<input type="text" value="1"/>
TCP Max Connect		100	<input type="text" value="100"/>
Without data Timeout		60	<input type="text" value="60"/>

Communication Parameter	Factory Default
Serial Configure	230400,8,n,1
Serial Framing Length	1050
Locale/Remote Port Number	5001

## IV. Network Mode Switch

86N series device support 4 network modes: Default · ETH(Ethernet) · Wi-Fi(STA)

Default	Ethernet (DHCP) +Wi-Fi AP mode
<b>ETH</b>	<b>Ethernet only</b>
WIFI(STA)	Wi-Fi client mode

1. **ETH** : Factory default is **ETH-SERIAL. ( Standard TCP/IP Reader )**

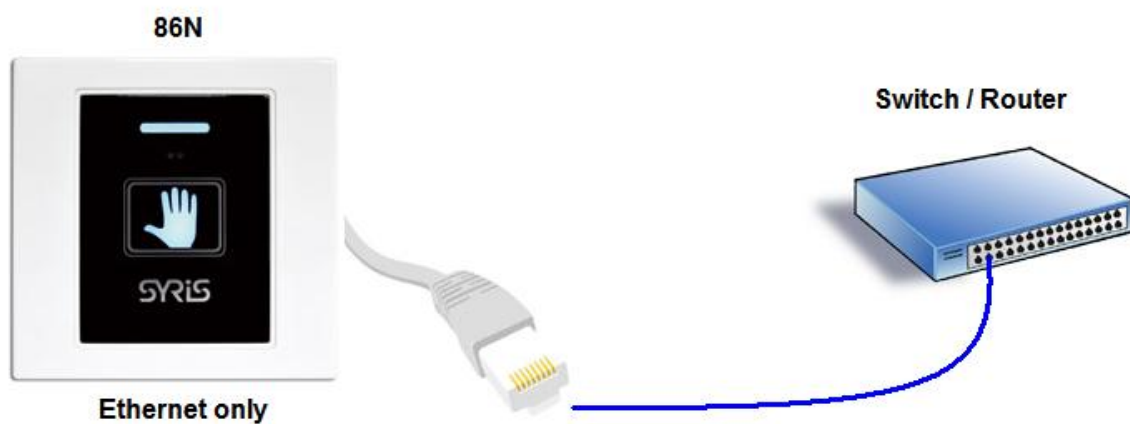

When user modify the IP and click on Apply button, device will reboot and apply the setting after 30 seconds.

	Current	Updated
Network Mode	Default	ETH ▾
IP Type	Static	Static ▾
IP Addr	192.168.1.101	192.168.1.101
Mask	255.255.255.0	255.255.255.0
Gateway	192.168.1.254	192.168.1.254
Dns	192.168.1.254	192.168.1.254

2. WIFI(STA) : 86N can be set to communicate via Wireless AP without Ethernet.



Settings		Network	Serial 0	Serial 1
	<b>Current</b>	<b>Updated</b>		
Network Mode	Default	WIFI(STA) ▾		
STA SSID	Delta-IoT	Delta-IoT	<input type="button" value="Scan"/>	
STA EncType	Open	Open ▾		
STA Passwd		<input type="text"/>		
IP Type	Static	Static ▾		
IP Addr	192.168.1.101	192.168.1.101 <input type="button" value="🔗"/>		
Mask	255.255.255.0	255.255.255.0		
Gateway	192.168.1.254	192.168.1.254		
Dns	192.168.1.254	192.168.1.254		

**STA SSID:** Enter the SSID from AP you will connect to network.

: User can scan AP in range of 86N and select one to connect. But user cannot scan the AP after changing default network mode (Ethernet only) to Wi-Fi (Client). 86N need to power off / on to enable the scan function.

**STA EncType :** Select Encrypt type for AP connection.

**Password:** Enter password for AP.

**IP Type:** DHCP is default mode. If user has to setup a static IP, please select Static.

**PS: Wi-Fi MAC address is Ethernet MAC subtract 1.**

**Ex. Ethernet MAC : AC:A2:13:B5:5A:B5 · Wi-Fi MAC : AC:A2:13:B5:5A:B4**



- 3. Default mode : Ethernet (DHCP) +Wi-Fi AP mode.  
It's Dual-Mode ( Ethernet and Wi-Fi AP · but Ethernet only support DHCP.)



	Current	Updated
Network Mode	Default	Default ▾
IP Type	Static	Static ▾
IP Addr	192.168.1.101	192.168.1.101 
Mask	255.255.255.0	255.255.255.0
Gateway	192.168.1.254	192.168.1.254
Dns	192.168.1.254	192.168.1.254
AP Enable	Enable	Enable ▾
AP SSID	SerialWiFi_0EAO	SerialWiFi_0EAO
AP EncType	WPA2AES	WPA2AES ▾
AP Passwd	12345678	12345678
LAN IP Addr	192.168.16.254	192.168.16.254
LAN Mask	255.255.255.0	255.255.255.0
DHCP Server	Enable	Enable ▾

**AP SSID:** Setup 86N device's SSID.

**AP Passwd:** 86N device's Wi-Fi password. (Default is 12345678)

## V. USB Connection

Setup 86N parameter via Micro USB.

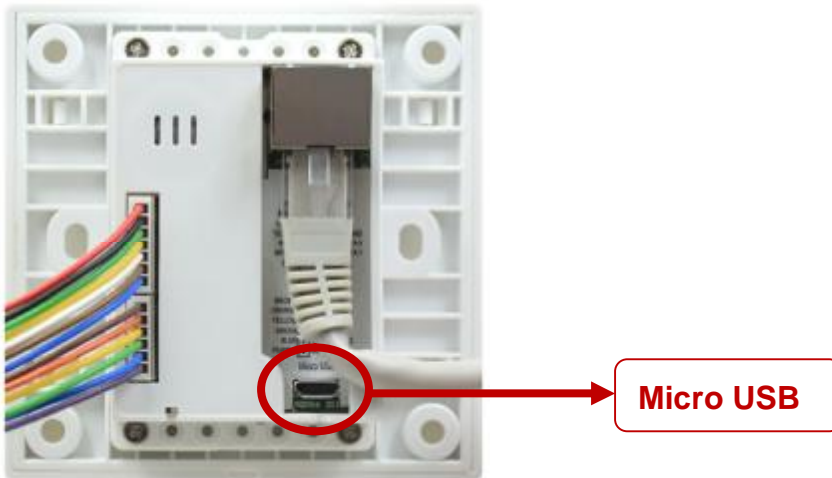

1. Install USB driver "CDC\_USB\_Driver\_VCP\_V1.4.0\_Setup.exe"
2. System will generate a virtual COM port.

For example. Check port in device manager.(below picture is COM 3)

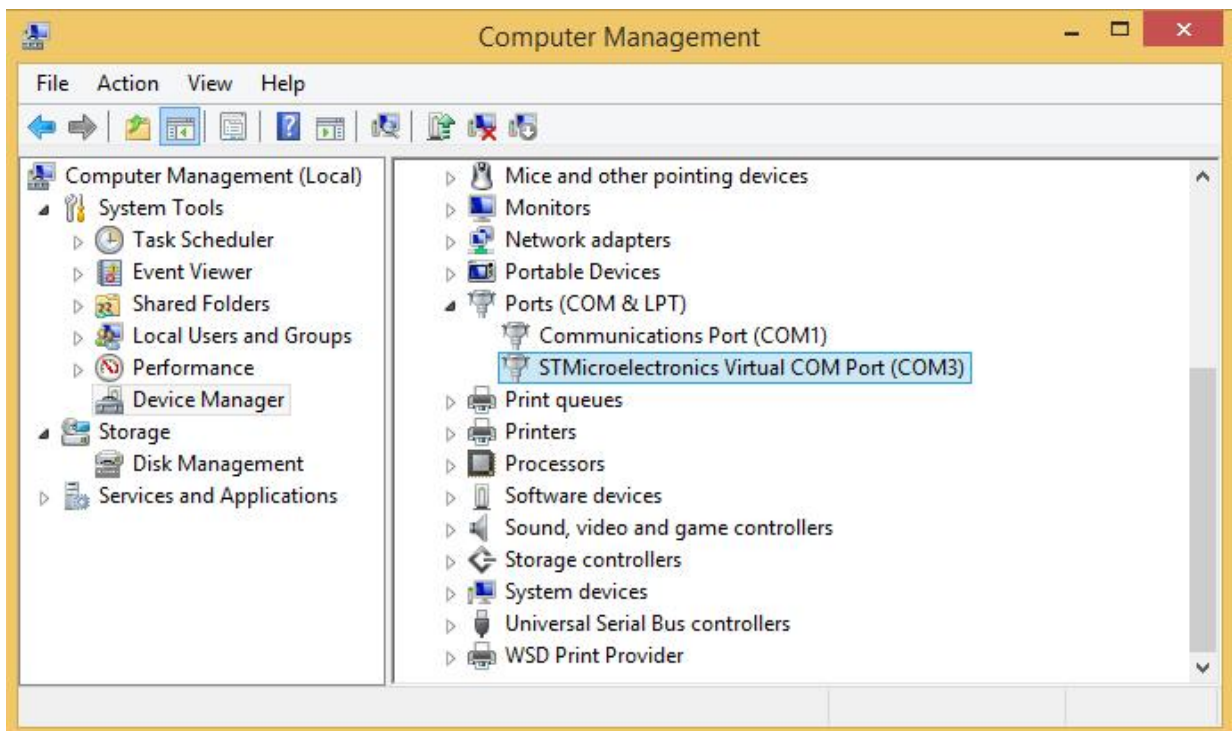

User also can update driver manually. The driver is saved in the folder that is same as following.

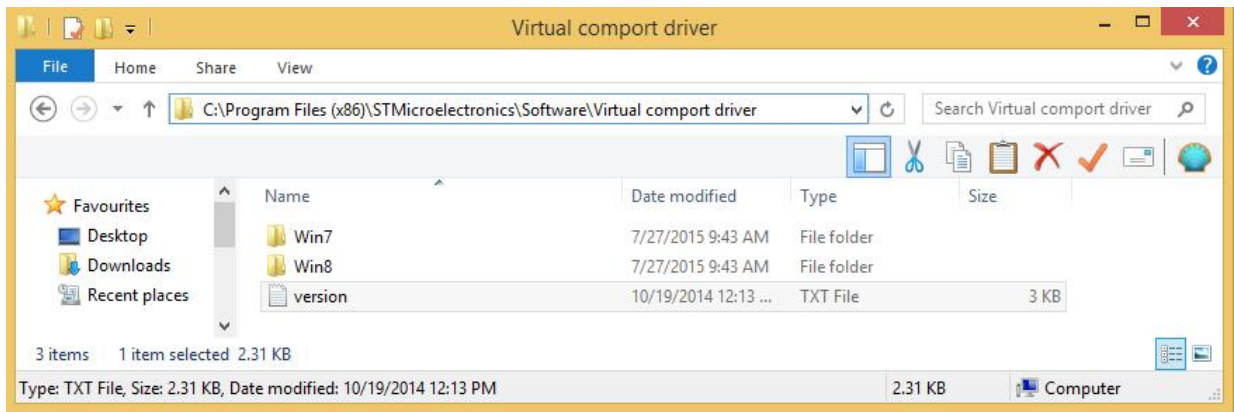

3. Get device Model information and serial number by using V8 Tools with correct COM port or Ethernet connection.

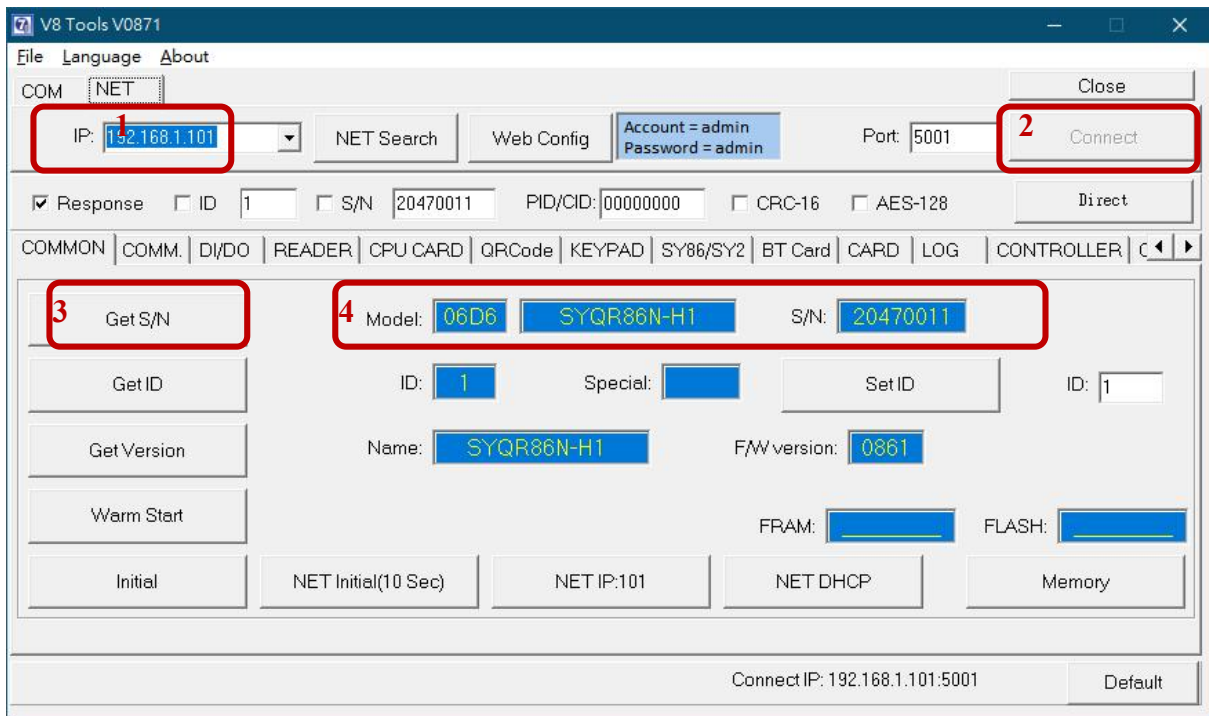

## VI. V8 Tools Tool Parameter Setting

### 1. Basic:

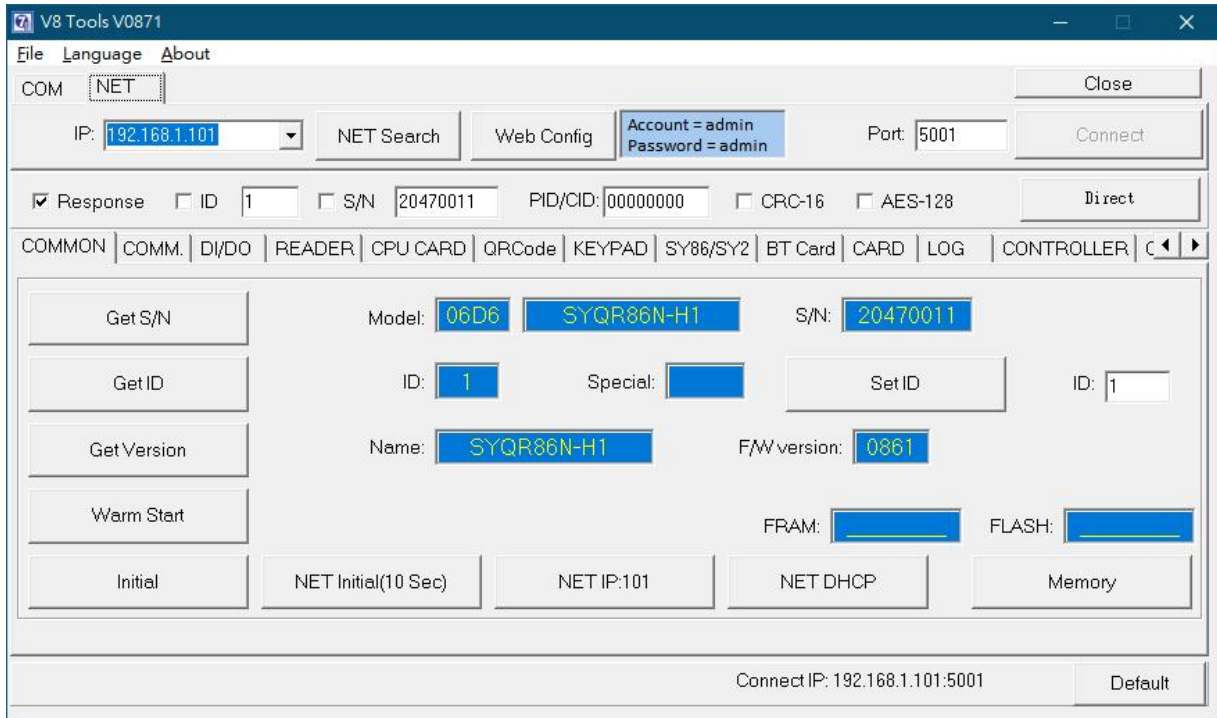

Basic: Get device serial number \ device ID and firmware version

Warm Start: Reboot 86N

Initial: Restore 86N to factory default (It is NOT including network setting).

NET Initial (6 sec): Restore network parameter of 86N to Default mode.

## 2. Reader

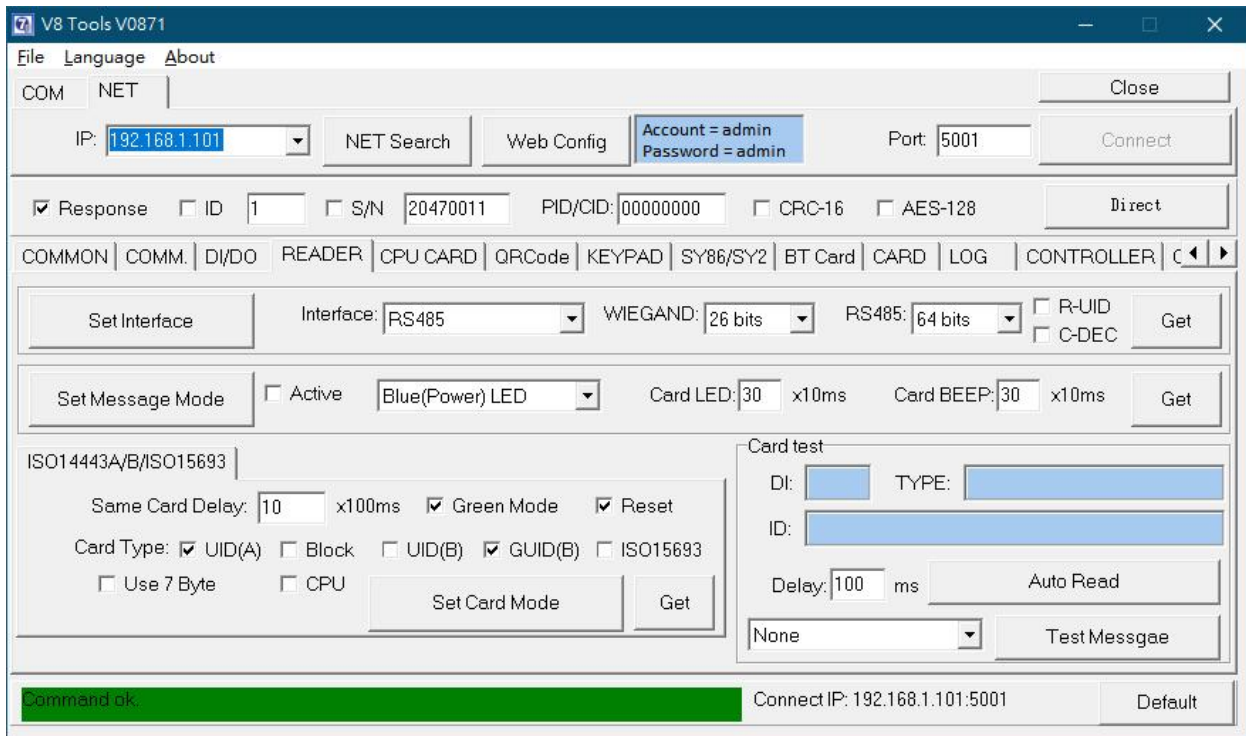

The screenshot shows the V8 Tools V0871 software interface. The main window has a menu bar (File, Language, About) and a toolbar with buttons for COM, NET, Close, IP (192.168.1.101), NET Search, Web Config, Account = admin, Password = admin, Port (5001), and Connect. Below the toolbar are several configuration sections:

- Response Section:** Includes checkboxes for Response (checked), ID (1), S/N (20470011), PID/CID (00000000), CRC-16, and AES-128. A Direct button is also present.
- Navigation Tabs:** COMMON, COMM., DI/DO, READER, CPU CARD, QRCode, KEYPAD, SY86/SY2, BT Card, CARD, LOG, CONTROLLER.
- Set Interface Section:** Interface: RS485, WIEGAND: 26 bits, RS485: 64 bits, R-UID, C-DEC, and a Get button.
- Set Message Mode Section:** Active checkbox, Blue(Power) LED, Card LED: 30 x10ms, Card BEEP: 30 x10ms, and a Get button.
- ISO14443A/B/ISO15693 Section:** Same Card Delay: 10 x100ms, Green Mode (checked), Reset (checked), Card Type: UID(A) (checked), Block, UID(B), GUID(B) (checked), ISO15693, Use 7 Byte, CPU, Set Card Mode, and Get buttons.
- Card test Section:** DI, TYPE, ID, Delay: 100 ms, Auto Read, None, and Test Message buttons.
- Status Bar:** Command ok, Connect IP: 192.168.1.101:5001, Default.

**Set Interface:** Setup reader's communication interface. Default is "RS485".

**Set Message Mode:** Click on the option active to enable message mode setting. User can setup 86N message display on panel.

Card LED: Time for read card LED ON, default is 30 x 10ms

Card Beep: Time for read card beep on, default is 30 x 10ms

### ISO14443A/B/ISO15693 :

Same Card Delay: Setup time gap for reading the same card, default is 10 x100ms (1 second)

Green Mode: Slow down the card read speed to power saving.

Reset: Reset RF IC after read card.

Card Type: Choose card type to enable 86N read specific card.

UID(A): Read ISO14443A Card UID.

Block: Read Block data (Must disable other card type).

UID(B): Read ISO14443B Card UID.

GUID(B): Read the China second generation of resident identification card.

ISO15693: Read ISO15693 Card UID

7 byte: Read 7byte format Card UID

Card Test: Test the reader function.

## Auto send reader mode

1. Un- Select "Controller Mode" and then click "Set DI/DO Mode" to disable controller mode.

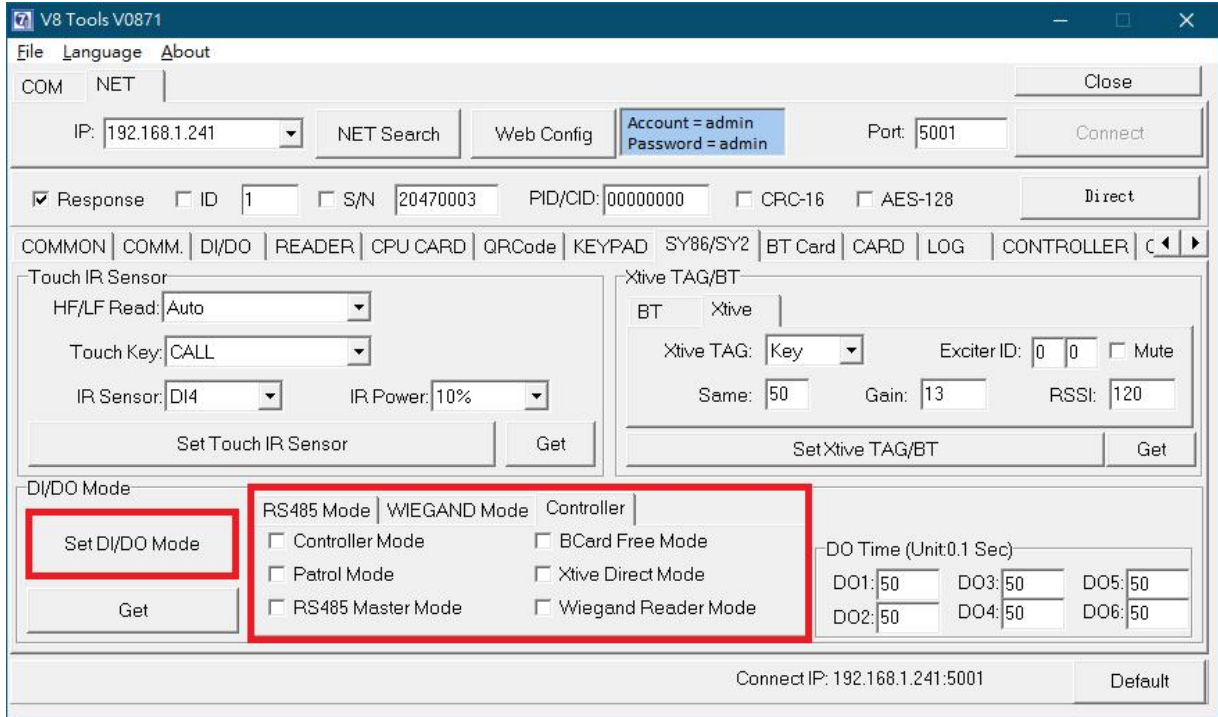

2. Select "EN" (means enable), "S/N", "CLR", "CRC" and set heartbeat to 50 (means 5 sec) and then click "Auto Mode" to finish configure.

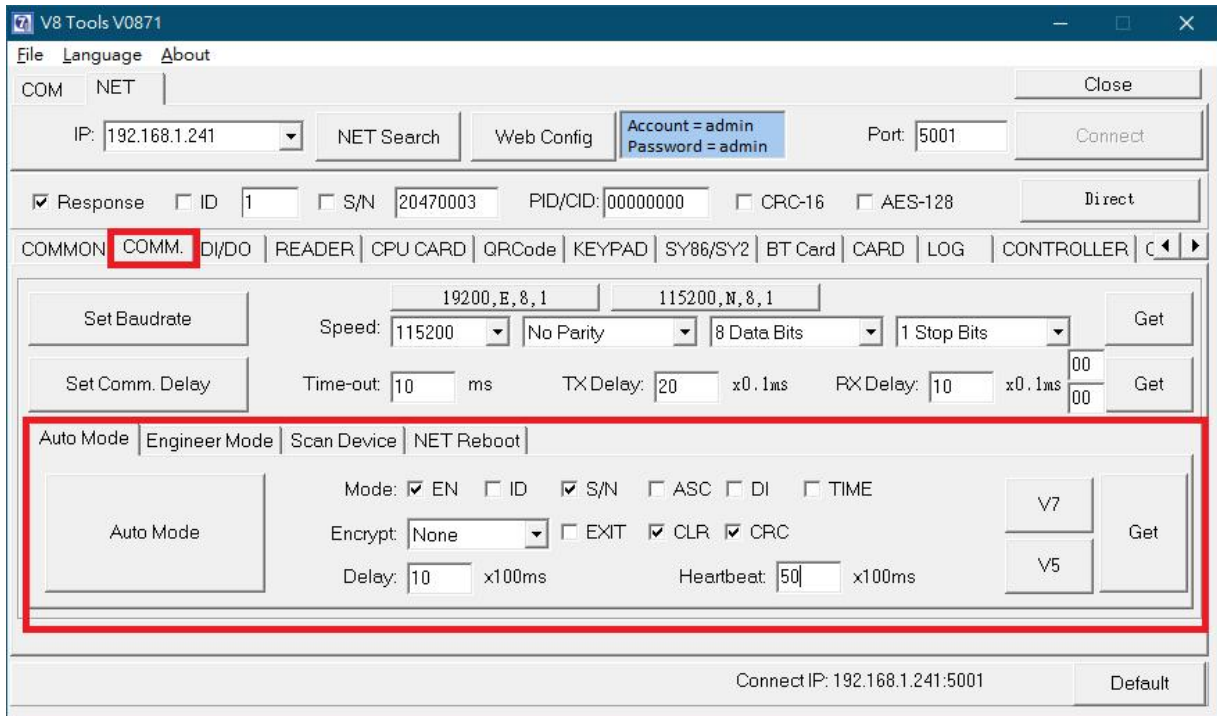

3. Execute "SYRIS TCP reader utility" to connect reader and start to read.

(This software only work with [auto send reader mode.](#))

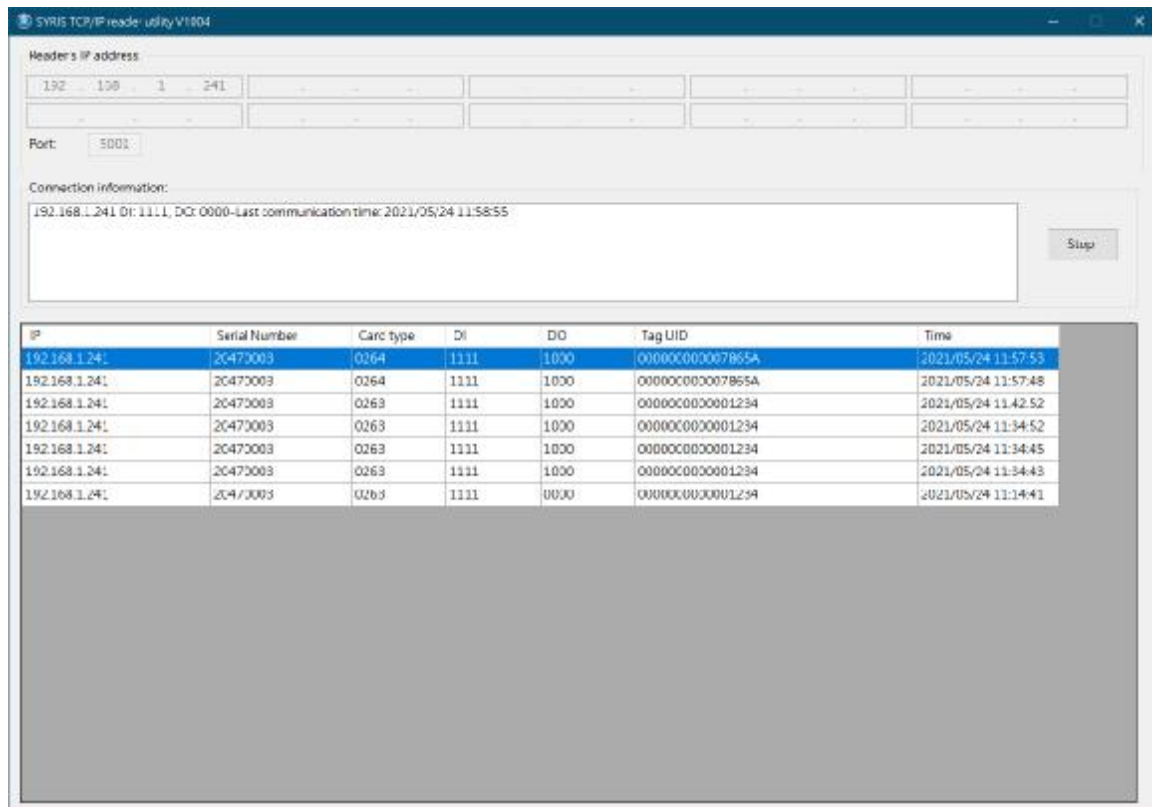

Card type:

0101	EM tag UID	0211	Desfire tag UID
0201	Mifare tag UID	0261	QR code (DEC)
0202	Mifare block data	0262	QR code (HEX)
0203	ISO 14443B tag UID	0263	QR code (SID)
0204	ISO15693 tag UID	0264	QR code (SID date)
0241	UHF tag UID		