

SYKD2N-H1

SYRIS TCP/IP OLED Display Reader

Operation Manual



Version 01.05

2021/09/24

I. Features & Specification

Feature:

- I Multi-mode access control
- I Support ISO15693 / ISO14443A (Mifare) / ISO14443B / DESFire / NTAG203
- I 2.42 inch OLED Display
- I Multi communication interface
- I Provide protocol to develop.

Specification:

Frequency	13.56MHz
Interface	RS485 / Wiegand / Ethernet / Wi-Fi
Wiegand	Wiegand (support 26/32/34/35/37/42/66 bits)
RS485 baud rate	19,200 bits/sec (4,800~460,800)
Ethernet	10M/100M Ethernet Port
Wi-Fi	802.11 b/g/n
Display	2.42 inch 128 x 64 OLED display
Status Indicator	Tricolor LED(RGB) & Beeper
Keypad	13 capacitive touch button
IR Sensor	1 IR sensor for waving hand to access door (adjustable range 0~10cm)
Digital Input	Up to 3 (1 DI+2 no-voltage DI share the same port with Wiegand)
Digital Output	Up to 4 (2 Relay output+ 2 open collector DO share the same port with Wiegand)
HF Protocols	ISO15693 / ISO14443A / ISO14443B / DESFire / NTAG203
HF Read range	Up to 5 cm
ID	0001~9999
Number of Cards	10000
Capacity of Records	100000
Power Supply	9 ~28 VDC (12 VDC)
Power consumption	1W~6W
Operating temperature	-10°C to 60°C
Dimensions (mm)	124 x 90 x 27mm

II. Wiring Diagram

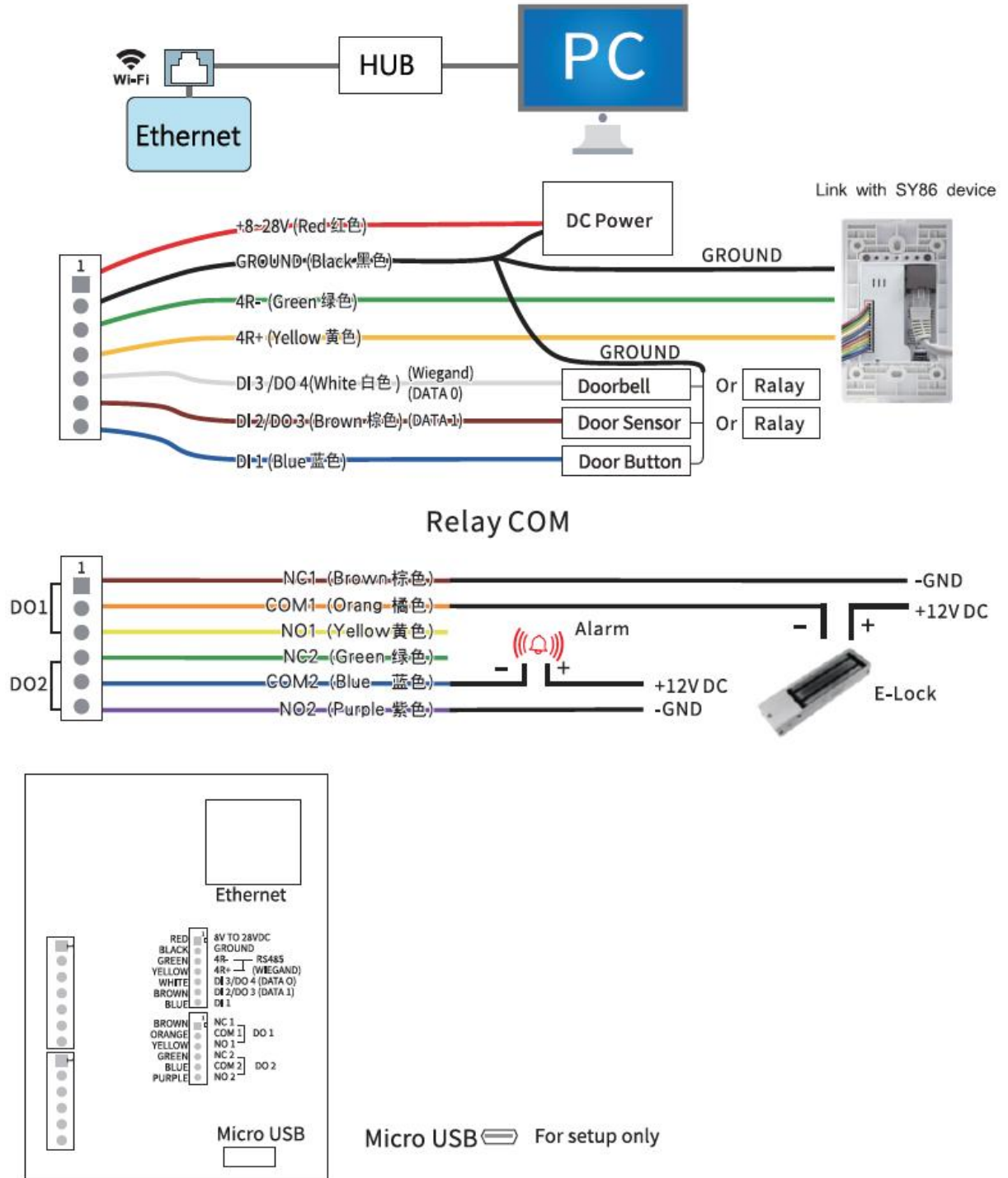

III. Network Parameter Setting

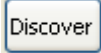
1. Execute "NET_Discover_V0110.exe" and press  to search SYRIS series product.
2. Factory default IP is "192.168.1.101". User can check the MAC address from product sticker with IP to confirm the device.

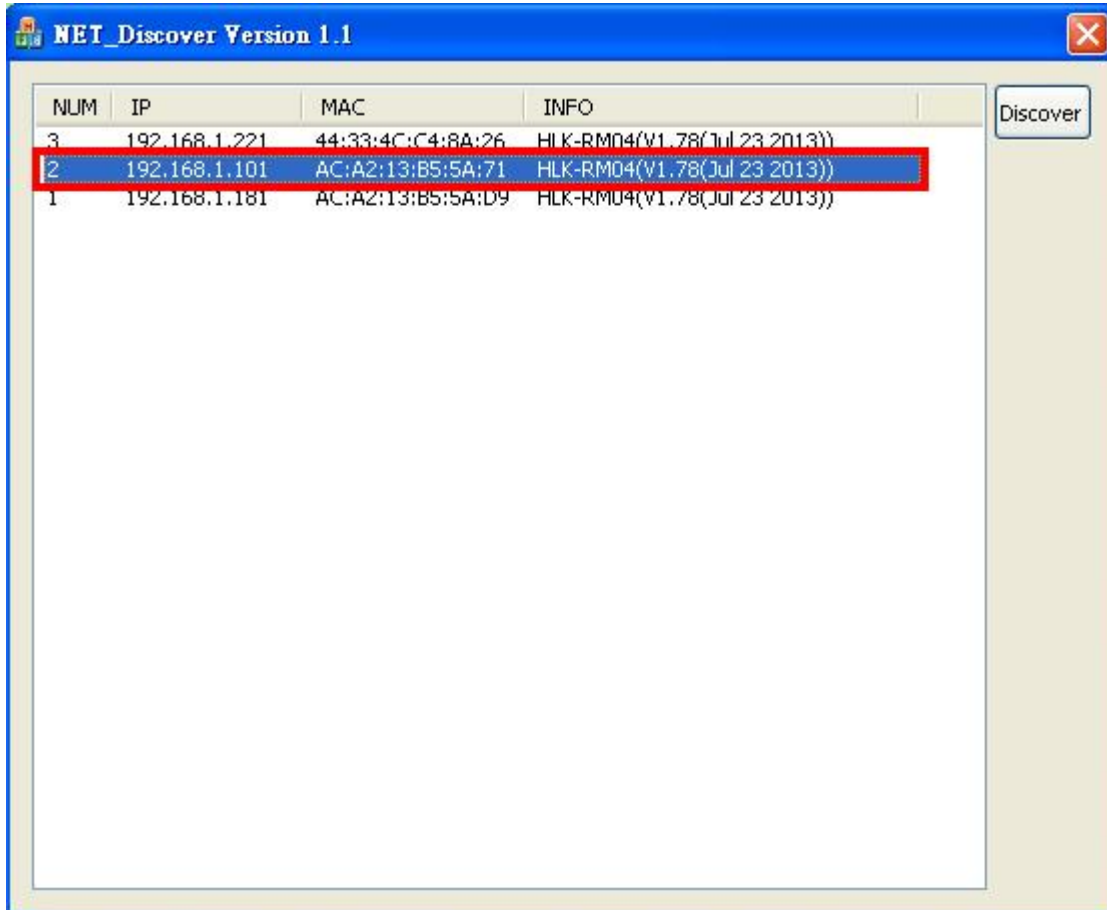

3. Double click IP (192.168.1.101) to open the web configure page(<http://192.168.1.101>)

Default login ID / Password : admin / admin

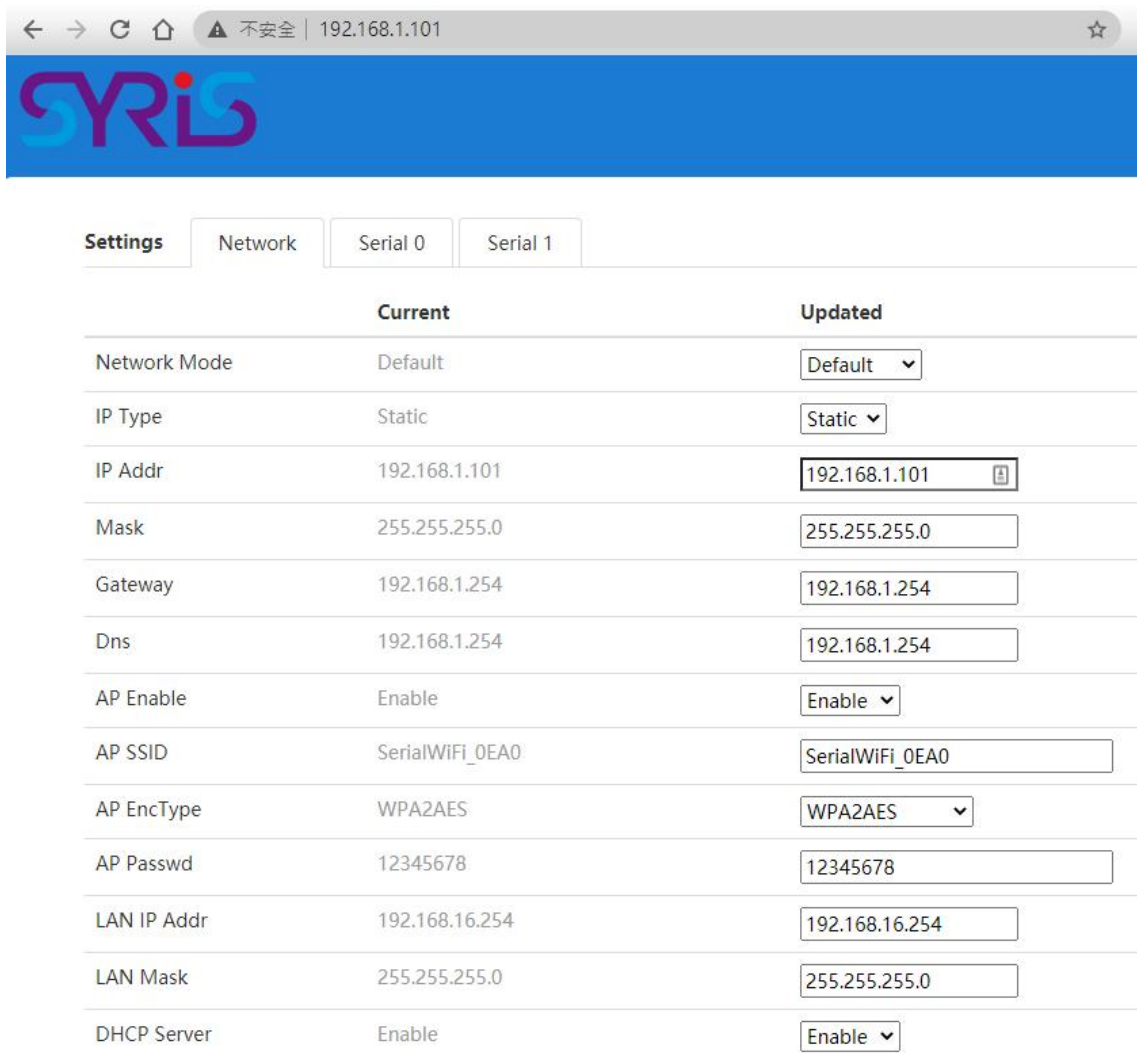

4. Default Net Mode is the same as the following. User can modify Net Mode and other parameters. If device cannot communicate properly after setting, user can reset NET module via Micro USB.

Settings			
	Network	Serial 0	Serial 1
		Current	Updated
Baudrate		230400	<input type="text" value="230400"/>
Data Width		8	<input type="text" value="8"/>
Parity		NONE	<input type="text" value="NONE"/>
Stop Bit		1	<input type="text" value="1"/>
Flow Control		Disable	<input type="text" value="Disable"/>
Socket Protocol Type		Tcp Server	<input type="text" value="Tcp Server"/>
Locale Port		5001	<input type="text" value="5001"/>
Packet Framing Lenth		1050	<input type="text" value="1050"/>
Packet Framing Timeout		3	<input type="text" value="3"/>
Packet Framing Interval		3	<input type="text" value="3"/>
TCP Timeout		0	<input type="text" value="0"/>
Reconnect Interval		200	<input type="text" value="200"/>
TCP Keep Alive		1	<input type="text" value="1"/>
TCP Max Connect		100	<input type="text" value="100"/>
Without data Timeout		60	<input type="text" value="60"/>

Communication Parameter	Factory Default
Serial Configure	230400,8,n,1
Serial Framing Length	1050
Locale/Remote Port Number	5001

IV. Network Mode Switch

SYRIS device support 4 network modes: Default · ETH(Ethernet) · Wi-Fi(STA)

Default	Ethernet (DHCP) +Wi-Fi AP mode
ETH	Ethernet only
WIFI(STA)	Wi-Fi client mode

1. ETH : Factory default is **ETH-SERIAL. (Standard TCP/IP Reader)**

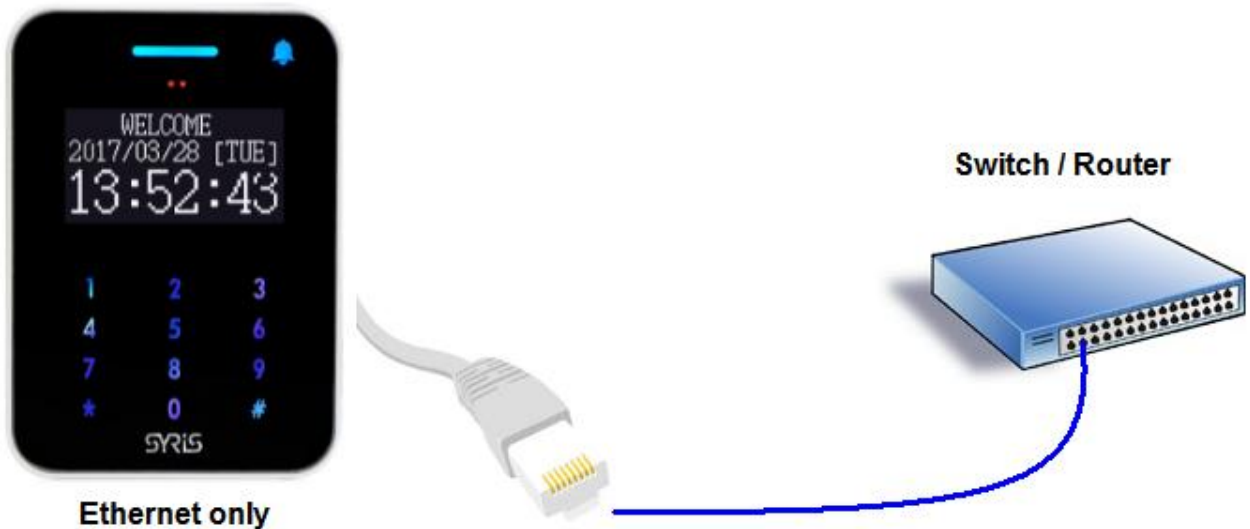

When user modify the IP and click on Apply button, device will reboot and apply the setting after 30 seconds.

	Current	Updated
Network Mode	Default	ETH ▾
IP Type	Static	Static ▾
IP Addr	192.168.1.101	192.168.1.101 
Mask	255.255.255.0	255.255.255.0
Gateway	192.168.1.254	192.168.1.254
Dns	192.168.1.254	192.168.1.254

2. WIFI(STA) : SYRIS can be set to communicate via Wireless AP without Ethernet.



Settings	Network	Serial 0	Serial 1
		Current	Updated
Network Mode	Default		WIFI(STA) ▾
STA SSID	Delta-IoT		Delta-IoT <input type="button" value="Scan"/>
STA EncType	Open		Open ▾
STA Passwd			<input type="text"/>
IP Type	Static		Static ▾
IP Addr	192.168.1.101		192.168.1.101 <input type="button" value="🔒"/>
Mask	255.255.255.0		255.255.255.0 <input type="text"/>
Gateway	192.168.1.254		192.168.1.254 <input type="text"/>
Dns	192.168.1.254		192.168.1.254 <input type="text"/>

STA SSID: Enter the SSID from AP you will connect to network.

: User can scan AP in range of device and select one to connect. But user cannot scan the AP after changing default network mode (Ethernet only) to Wi-Fi (Client). Device need to power off / on to enable the scan function.

STA EncType : Select Encrypt type for AP connection.

Password: Enter password for AP.

IP Type: DHCP is default mode. If user have to setup a static IP, please select Static.

PS: Wi-Fi MAC address is Ethernet MAC subtract 1.

Ex. Ethernet MAC : AC:A2:13:B5:5A:B5 · Wi-Fi MAC : AC:A2:13:B5:5A:B4

- 3. Default mode : Ethernet (DHCP) +Wi-Fi AP mode.
It's Dual-Mode (Ethernet and Wi-Fi AP · but Ethernet only support DHCP.)



	Current	Updated
Network Mode	Default	Default ▾
IP Type	Static	Static ▾
IP Addr	192.168.1.101	192.168.1.101 
Mask	255.255.255.0	255.255.255.0
Gateway	192.168.1.254	192.168.1.254
Dns	192.168.1.254	192.168.1.254
AP Enable	Enable	Enable ▾
AP SSID	SerialWiFi_0EA0	SerialWiFi_0EA0
AP EncType	WPA2AES	WPA2AES ▾
AP Passwd	12345678	12345678
LAN IP Addr	192.168.16.254	192.168.16.254
LAN Mask	255.255.255.0	255.255.255.0
DHCP Server	Enable	Enable ▾

AP SSID: Setup device's SSID.

AP Passwd: Device's Wi-Fi password. (Default is 12345678)

V. USB Connection

Setup parameters via Micro USB.

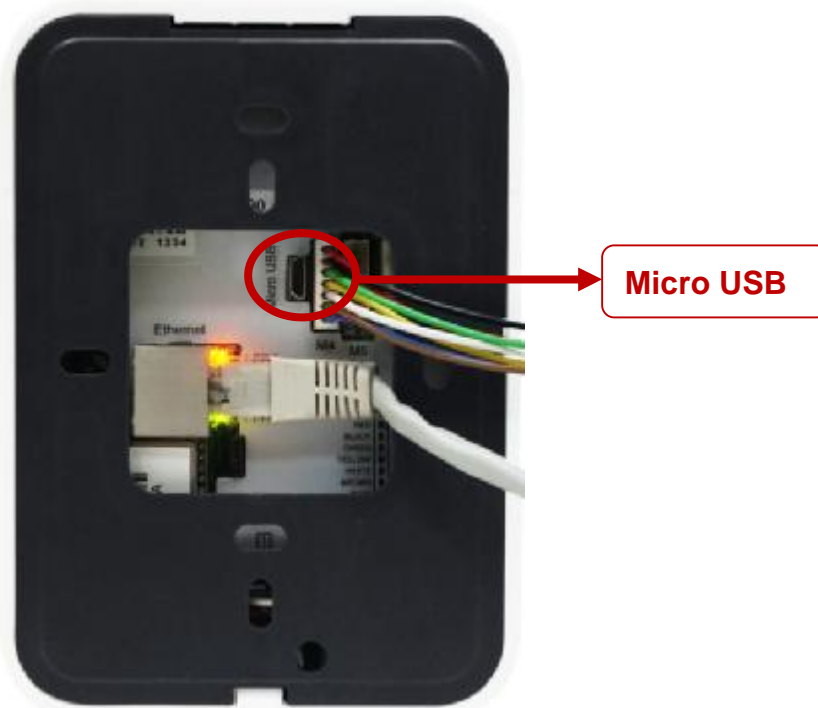

1. Install USB driver "CDC_USB_Driver_VCP_V1.4.0_Setup.exe"
2. System will generate a virtual COM port.

For example. Check port in device manager.(below picture is COM 3)

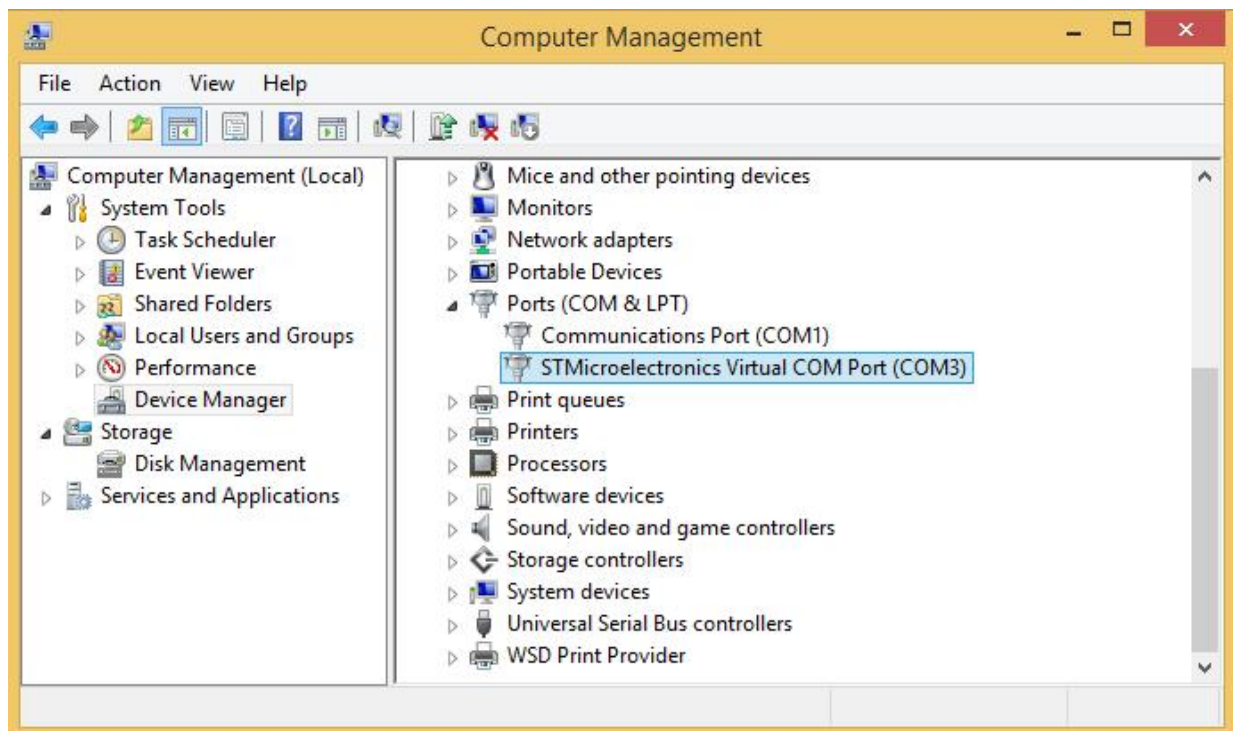

User also can update driver manually. The driver is saved in the folder that is same as following.

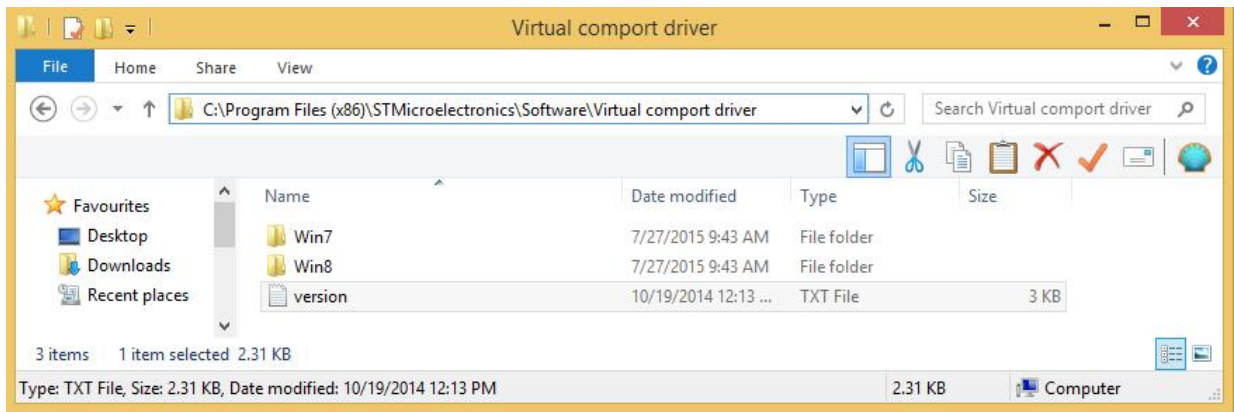

3. Get device Model information and serial number by using V8 Tools with correct COM port or Ethernet connection.

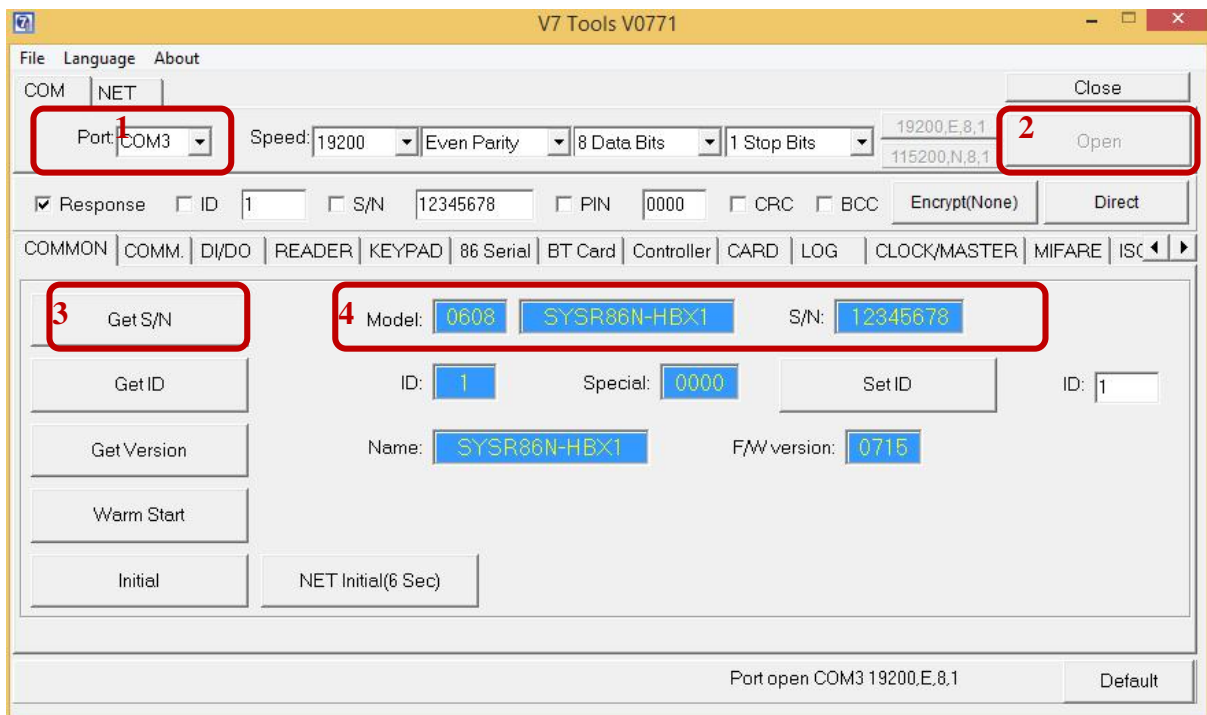

VI. V8 Tools Tool Parameter Setting

1. Basic:

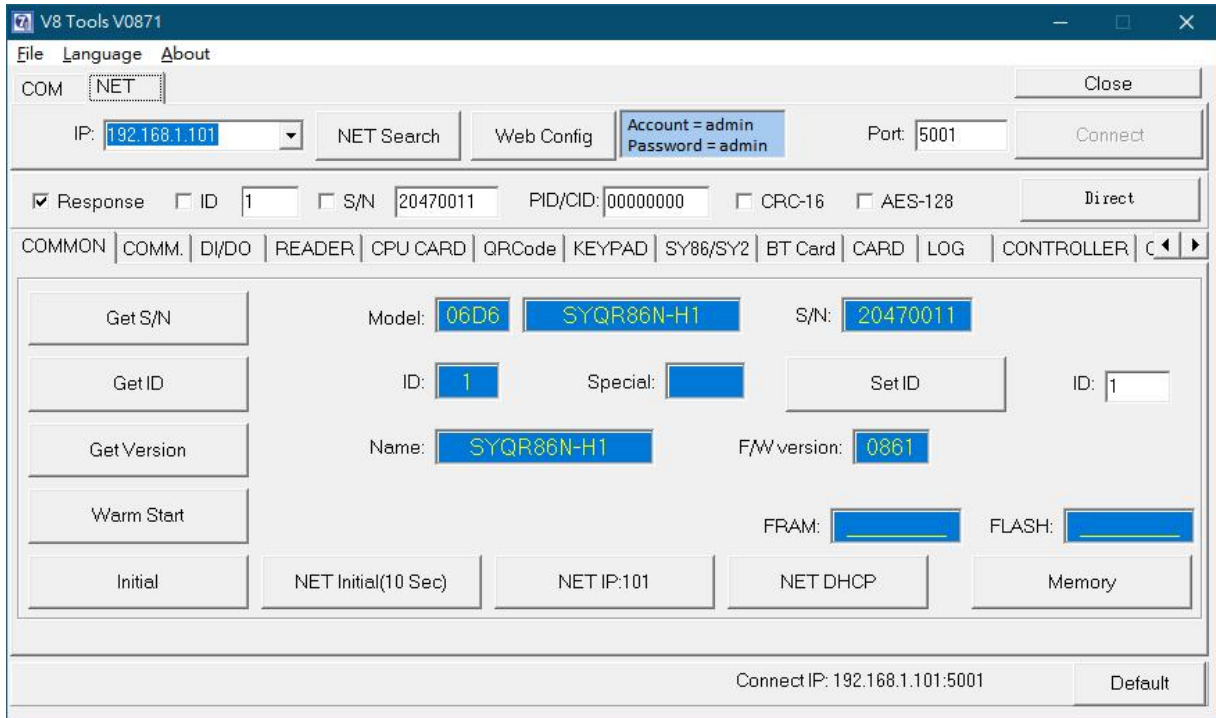

Basic: Get device serial number \ device ID and firmware version

Warm Start: Reboot device

Initial: Restore device to factory default (It is NOT including network setting).

NET Initial (6 sec): Restore network parameter of device to Default mode.

2. Reader

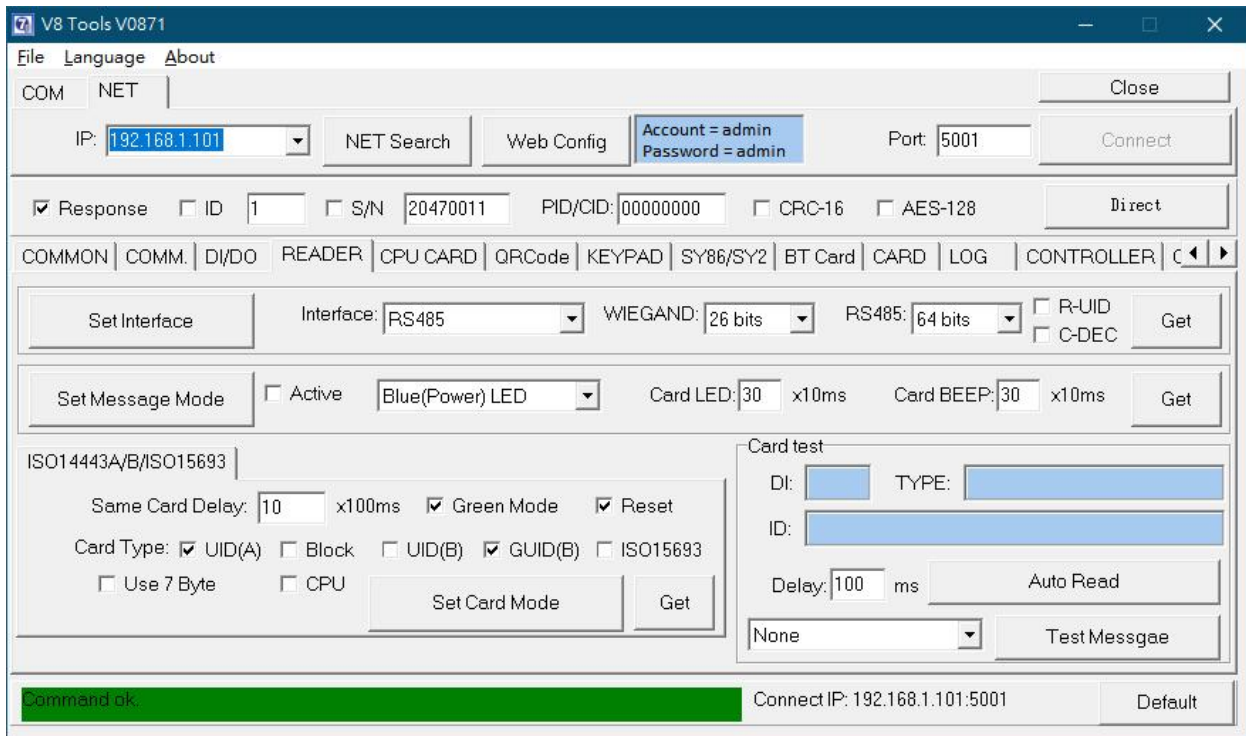

Set Interface: Setup reader's communication interface. Default is "RS485".

Set Message Mode:

Card LED: Time for read card LED ON, default is 30 x 10ms

Card Beep: Time for read card beep on, default is 30 x 10ms

ISO14443A/B/ISO15693 :

Same Card Delay: Setup time gap for reading the same card, default is 10 x100ms (1 second)

Green Mode: Slow down the card read speed to power saving.

Reset: Reset RF IC after read card.

Card Type: Choose card type to enable device's read specific card.

UID(A): Read ISO14443A Card UID.

Block: Read Block data (Must disable other card type).

UID(B): Read ISO14443B Card UID.

GUID(B): Read the China second generation of resident identification card.

ISO15693: Read ISO15693 Card UID

7 byte: Read 7byte format Card UID

Card Test: Test the reader function.

3. Display : Set up display language and encode for different country.

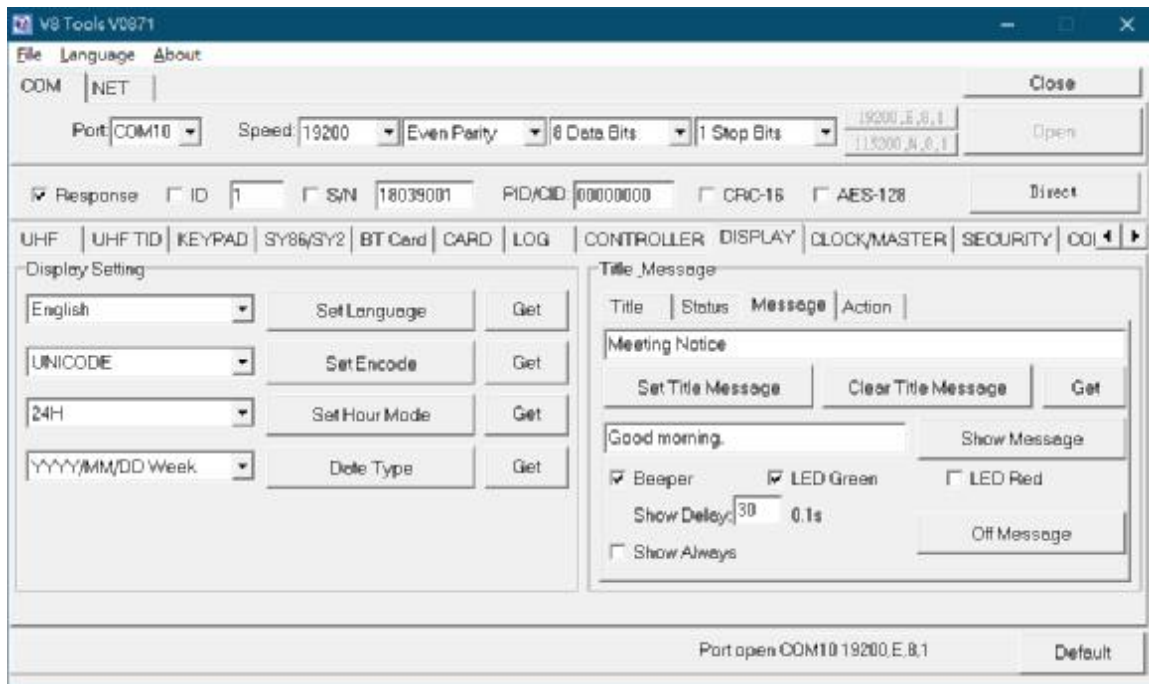

Test send message command with tools.

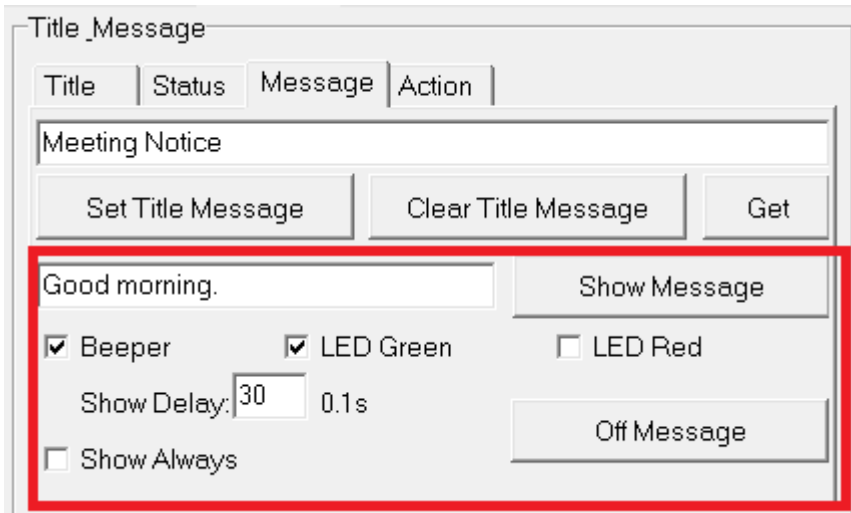

Auto send reader mode

1. Un- Select "Controller Mode" and then click "Set DI/DO Mode" to disable controller mode.

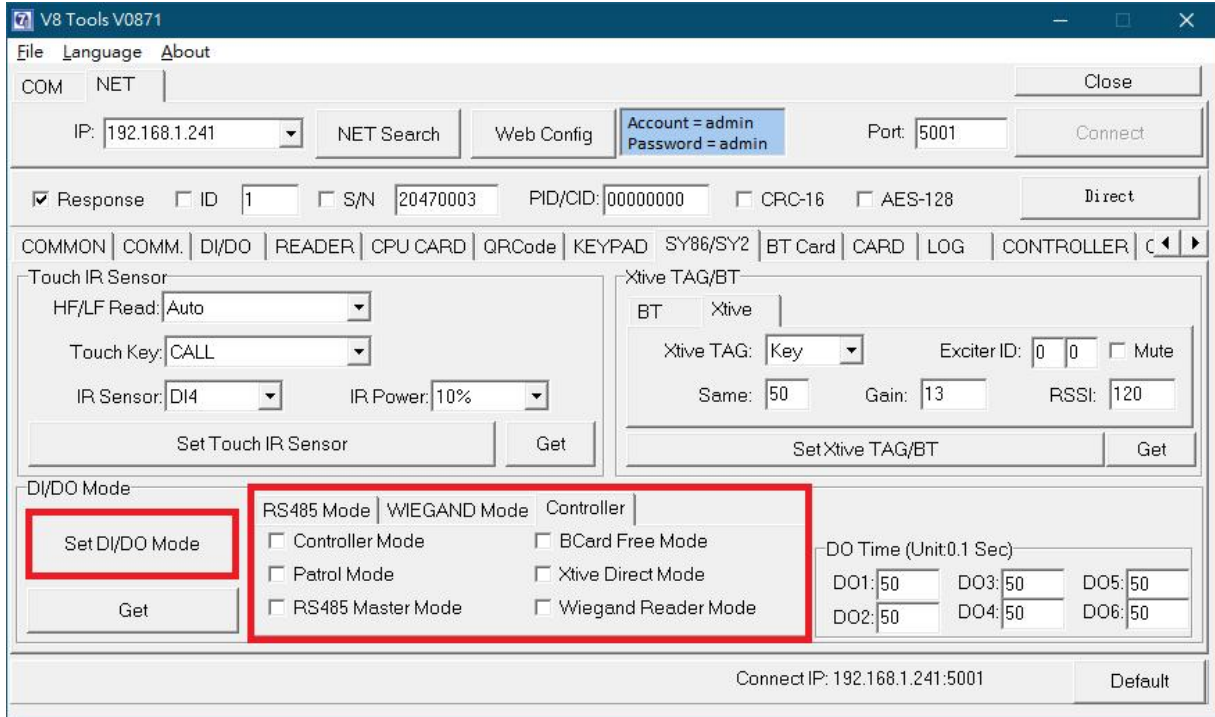

2. Select "EN" (means enable), "S/N", "CLR", "CRC" and set heartbeat to 50 (means 5 sec) and then click "Auto Mode" to finish configure.

